

SCREWDRIVERS

INTRODUCTION

We Satisfy Market Needs

KUANI is dedicated in developing products that can be used with minimal effort, have the highest standard of user comfort and safety, and will be manufactured in the most eco-friendly way as possible.

Intended Use

- Application context
- Performance requirement

User Comfort

- Working posture
- Safety regulation

Need Customization?

- Choose a product model from our category
- Tell us your specifications
- Or, simply send us a sample and your specifications

SCREWDRIVER



DESIGN

- User's health & safety is our priority
- Market-oriented
- Professional engineering
- Prototype and mold
- Ability of developing test instruments and equipment

1

PRODUCTION

- High ratio of self-manufactured content
- Integrated production lines
- 300 CNC machines
- Mass production ability

2

QUALITY ASSURANCE

- Compliance with the regulation of safety requirement
- Total quality management
- KENTE Laboratory for testing vibration and noise

3

About KUANI

KUANI has been the market leader in design, manufacture and distribution for all quality air tools produced in Taiwan for 30 years. KUANI's strong manufacturing capability is supported by around 400 experienced personnel operating over 300 CNC machines with the ability to make over 85% of all parts used in all KUANI products within KUANI's portfolio.



KUANI understands the value of quality and complies with ISO 9001:2015 and has been certificated within the fields of Manufacturing, R&D and Sales of hand tools and power tools. KUANI promises that each product has been strictly manufactured and checked based on the original design and pre-set frequency of use. When designing air tools, KUANI maintains user safety and comfort without compromising the tool's function. KUANI can offer clients an integrated service from design to mass production.

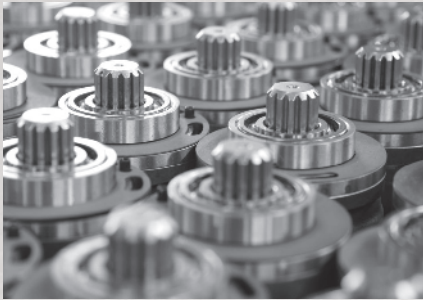

KUANI's Services:

- Precision Parts Machining Division
- Power Tools Manufacturing (OEM and ODM)
- Investment Casting & Processing
- Sound & Vibration Laboratory

In 2010, KUANI established the **KENTE** vibration and noise of power tool testing laboratory which is the first licensed vibration and noise of power tool testing laboratory in Taiwan. The KENTE laboratory complies with ISO/IEC 17025 and has been certificated by TAF and ILAC-MRA. It also offers a professional testing and consultancy service within the CE regulation of portable air tools.

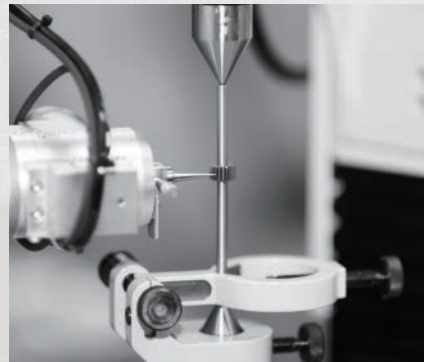

CONTENTS

Screwdriver Features to Be Considered	5
KUANI Clutch Selection Guide	7
Screwdriver Torque Range Selection	9
KUANI Premium Screwdrivers	10
Double Trigger Screwdriver	19
Classic Screwdriver	25
Shut-off Screwdriver	33
Shut-off Nut Runner	57
Torque Tester	61
Index	63
Sound & Vibration	67

KUANI Screwdrivers

KUANI carries on developing air screwdrivers to satisfy fastening tasks from craft worker to assembly lines. KUANI offers models of varied clutch types, speeds and torque ranges, meeting various requirements on torque performance and on the controllability of the final fastening force relating to the different joint types. Customization is welcome and can be negotiated.



SCREWDRIVER

Screwdriver Features to Be Considered:

A. Clutch Types

Nine clutch types can be seen in KUANI Air Screwdrivers.

Prevailing Clutch Designs:

For different requirements on torque control.



Direct Drive:

Motor directly drives fastener until stall torque is reached. Air pressure affects torque performance.



Positive Clutch:

Clutch mechanism generates less reaction force. Operator can re-engage the clutch jaws for extra torque output.



Externally Adjustable Clutch:

Torque is set by turning an external torque locator that adjusts the spring tension. More torque can be created by re-engaging the clutch jaws.



Adjustable Cushion Clutch:

This clutch type is also called adjustable rolling ball clutch. The rolling ball design is added to disengage and prevent re-engaging the clutch jaws when the preset torque is met. Torque is set by internal adjustment on the spring force.

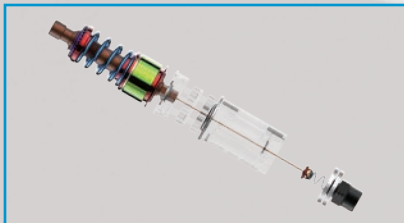

Shut-off Clutch:

Tool automatically stops when preset torque is reached. Ideal for highly demanding fastening work. KUANI has models of different speed and torque range.

Impact Clutches:

For application with less requirement on torque accuracy. The impact mechanism gives high power, high speed, and less reaction force.

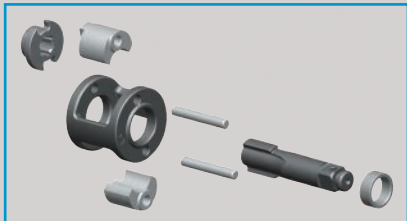

Twin Dog Clutch:

A powerful mechanism with a smooth increasing torque and low reaction force.

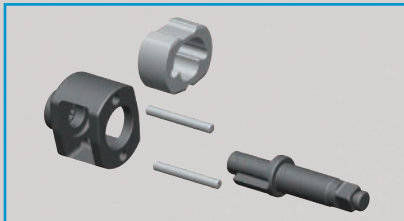

Jumbo Hammer:

This simple mechanism produces a huge torque output but with a higher vibration.

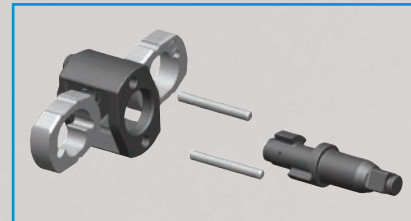

Twin Hammer:

A balanced and powerful mechanism with a low reaction force and smooth increase to maximum torque.



Twin Pinless Clutch:

A simplified and enhanced twin dog clutch equip with a full-caged hammer case, and altogether double tool service life, increase torque output by 20%, and is easy for maintenance.

B. Retainer Types



Hex. F. Quick Change Chuck

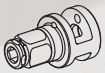

Dual-function Retainer:

The anvil design allows the fitting of either a normal square drive socket or a screwdriver hexagon bit.



Square Drive Anvil (Nut Runner)

C. Start / Stop Devices



Single Trigger:
Common design.



Double Trigger:
Two triggers in a line for easy switching between forward and reverse direction.



Lever:
Fitted along the grip. This type can be seen on most straight tools.



Rocking Lever:
A lever that not only controls start and stop but also the rotation. This type can also be seen on some short and straight handle types.



Push to Start Device:
Fitted to some straight handle models

D. Direction Control Devices



Slide Switch



Toggle Switch



Paddle Switch



Double Trigger Switch



Button Reverse



Ring Reverse

E. Handle Grip Types



Pistol:
For vertical work.











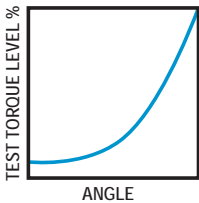
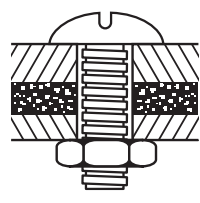
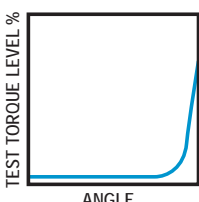
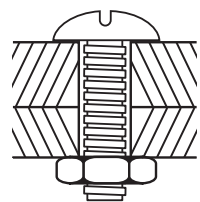
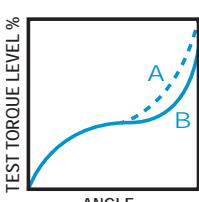
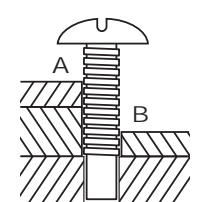
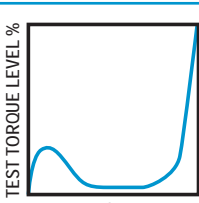
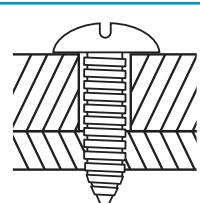
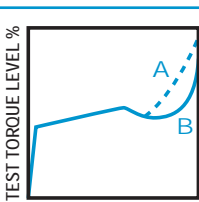
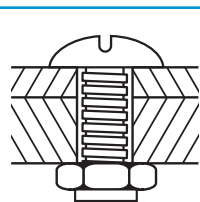
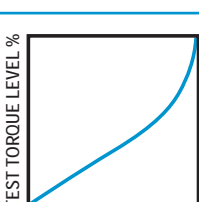
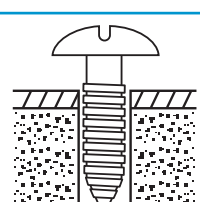



























Straight:
For horizontal work.

SCREWDRIVER

KUANI Clutch Selection Guide

The application decides the choice of clutch type. The following table indicates the most likely combination. However, on-site trials are recommended for assuring the suitability of the tool.

Joint Type	Description	Curve	Graph
Soft Stop	Turns easily and gradually builds up torque as the material is compressed		
Hard Stop	Turns easily until torque builds up and of a solid stop upon the screw head seated		
Self-tapping in thick material	Constant resistance during application with a gradual (A) or sudden (B) final build-up on torque		
Sheet metal Screws	Encounters with some resistance during the formation of the thread in the hole and then meets less resistance before the final sharp build up on torque		
Locknuts	High resistance during application with a gradual or sharp final build up on torque		
Wood Screws	Have small starting resistance that steadily increase through entire travel and meet heavy resistance when screw head seated		

				
Direct Drive	Positive Clutch	Externally Adjustable Clutch	Adjustable Cushion Clutch	Shut-off Clutch
 Fair	 Good	 Good	 Excellent	 Excellent
 Poor	 Fair	 Good	 Good	 Excellent
 Good	 Excellent	 Excellent	 Good	 Poor
 Poor	 Fair	 Excellent	 Good	 Fair
 Good	 Fair	 Excellent	 Good	 Poor
 Excellent	 Excellent	 Excellent	 Poor	 Poor

SCREWDRIVER

Screwdriver Torque Range Selection

Model	Clutch Mechanism	Torque Range ft-lb	Torque Range in-lb	Torque Range Nm	Free Speed R. P. M.	Handle Type
Direct Drive						
KI-3277	Direct Drive Clutch		65	7.3	3,000	Pistol
KI-3273	Direct Drive Clutch		75	8.5	2,200	Pistol
KI-3281	Direct Drive Clutch		120	13.6	1,200	Pistol
KI-3251	Direct Drive Clutch		70	7.9	1,800	Pistol
Positive Clutch						
KI-3274	Positive Clutch		75	8.5	3,000	Pistol
KI-3270	Positive Clutch		100	11.3	2,200	Pistol
KI-3278	Positive Clutch		140	15.8	1,200	Pistol
KI-3220	Positive Clutch		20~115	2.3~13.0	1,800	Pistol
Versa Clutch						
KI-3276	Externally Adjustable Clutch		5~75	0.6~8.5	3,000	Pistol
KI-3272	Externally Adjustable Clutch		17~100	1.9~11.3	2,200	Pistol
KI-3280	Externally Adjustable Clutch		5~140	0.6~15.8	1,200	Pistol
KI-3213	Externally Adjustable Clutch		45~115	5.1~13.0	1,800	Pistol
KI-3217	Externally Adjustable Clutch		20~115	2.3~13.0	1,800	Pistol
Adjustable						
KI-3275	Adjustable Cushion Clutch		20~75	2.3~8.5	3,000	Pistol
KI-3271	Adjustable Cushion Clutch		37~100	4.2~11.3	2,200	Pistol
KI-3279	Adjustable Cushion Clutch		20~140	2.3~15.8	1,200	Pistol
KI-3211	Adjustable Cushion Clutch		45~145	5.1~16.4	1,800	Pistol
KI-3215	Adjustable Cushion Clutch		20~115	2.3~13.0	1,800	Pistol
Impact Mechanism						
KI-3201-QL	Twin Dog	50		68	11,000	Straight
KI-3221-QC	Twin Dog	80		108	12,000	Straight
KI-3202-QL	Twin Dog	150		203	8,500	Straight
KI-3202-P-QL	Twin Dog	150		203	8,500	Pistol
KI-3266-P-QL	Twin Dog	150		203	8,500	Pistol
KI-311-JS	Jumbo Hammer	200		271	10,000	Pistol
KI-411-JHS	Jumbo Hammer	200		271	10,000	Pistol
KI-3290-P-QL	Twin Dog	250		339	8,500	Pistol
KI-3291-P-QL	Twin Dog	350		475	7,300	Pistol
KI-3269-P-QL	Twin Hammer	350		475	10,000	Pistol

KUANI Premium Screwdrivers



SCREWDRIVER

KUANI offers premium screwdrivers for professionals who need reliable tools for their work. Being made of precision-machined parts, these high quality premium screwdrivers have enhanced tool performance and longer tool life. With proven durability, KUANI premium screwdrivers are recommended for craft woodwork, wood construction, and white goods assembly lines. KUANI also provides models of different clutch types, torque ranges and speeds in this series.

SCREWDRIVER

Direct Drive Clutch (Stall Drive Clutch)

SCREWDRIVER

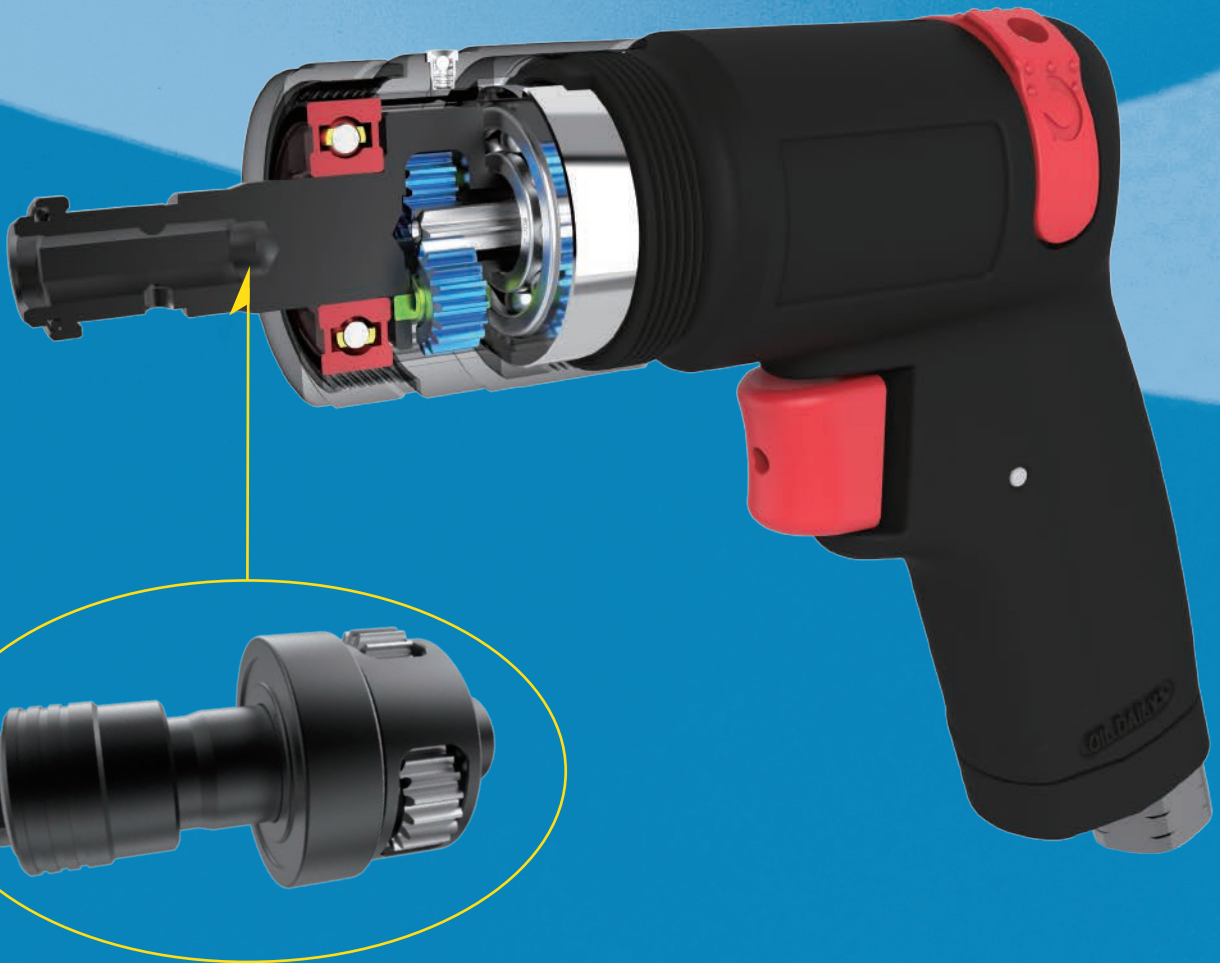

The power of this type is transmitted from the motor without a clutch. Therefore the torque performance of this air direct drive screwdriver is determined by the air pressure. This type of tool continues fastening until the resistance is reached and is ideal for wood screws, self-tapping screws and locknuts.

KI-3281

Direct Drive Clutch

1/4" Hex. Super Duty Air Screwdriver

- Torque up to 120 in-lb (13.6 Nm) under 90 psi
- Free speed at 1200 rpm
- Smooth trigger
- Ergonomic grip with a slide switch for changing direction
- Premium light weight screwdriver with basic fastening capability
- Ideal for wood screws and general carpentry applications



MODEL	FREE SPEED R. P. M.	OVERALL LENGTH INCH(mm)	AIR INLET INCH	AIR HOSE I.D	AVG. AIR CONSUMPTION cfm(L/min)	NET WEIGHT lb(kg)
KI-3281	1,200	7.3(185)	1/4	3/8	3.9(111)	2.80(1.27)

KI-3273

Direct Drive Clutch

1/4" Hex. Super Duty Air Screwdriver

- Torque range up to 75 in-lb (8.5 Nm) under 90 psi
- Free speed at 2200 rpm
- Well-designed grip and trigger
- Slide-type direction switch
- Premium light weight screwdriver
- Ideal for wood screws and general carpentry applications



MODEL	FREE SPEED R. P. M.	OVERALL LENGTH INCH(mm)	AIR INLET INCH	AIR HOSE I.D	AVG. AIR CONSUMPTION cfm(L/min)	NET WEIGHT lb(kg)
KI-3273	2,200	5.9(151)	1/4	3/8	3.9(111)	2.16(0.98)

KI-3277

Direct Drive Clutch

1/4" Hex. Super Duty Air Screwdriver

- Torque range up to 65 in- lb (7.3 Nm) under 90 psi
- Free speed at 3000 rpm
- Ergonomic grip for user comfort
- Equip with a smooth slide direction switch
- Premium durable screwdriver
- Productive and light weight tool
- Ideal for wood screws and general carpentry applications



MODEL	FREE SPEED R. P. M.	OVERALL LENGTH INCH(mm)	AIR INLET INCH	AIR HOSE I.D	AVG. AIR CONSUMPTION cfm(L/min)	NET WEIGHT lb(kg)
KI-3277	3,000	5.9(151)	1/4	3/8	3.9(111)	2.16(0.98)

SCREWDRIVER

Positive Clutch

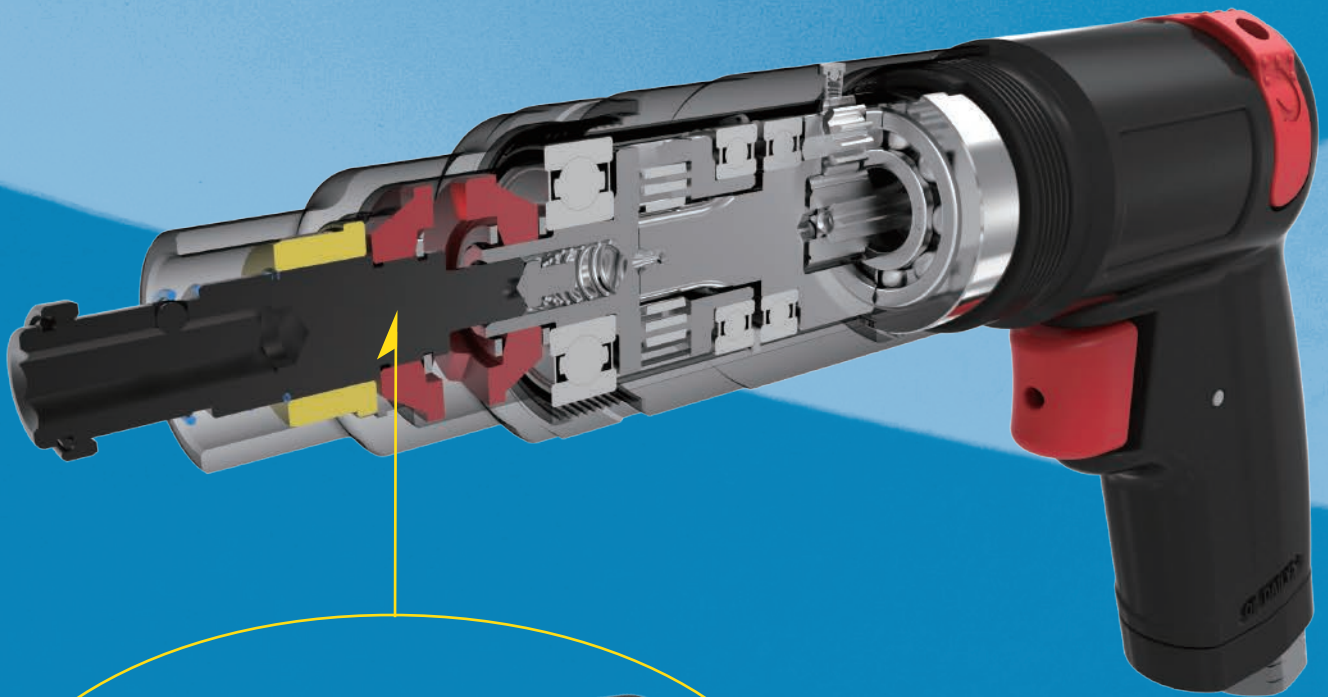

SCREWDRIVER



A clutch is added in the mechanism to increase torque performance and help decrease the reaction force. During operation the clutch jaws start to slip when meeting the stall torque. If the slipping action continues, torque will accumulate on the fastener. Extra driving torque can be applied by re-engaging clutch jaws. Positive clutch suits fastening tasks carried on inconsistent materials and excessive torque is permissible.

KI-3278

Positive Clutch

1/4" Hex. Super Duty Air Screwdriver

- Torque range up to 140 in-lb (15.8 Nm)
- Free speed at 1200 rpm
- Well-designed slide direction switch
- Comfortable grip handle
- Premium powerful screwdriver
- High torque with less reaction force
- Ideal for wood screws and self-tapping screws



MODEL	FREE SPEED R. P. M.	OVERALL LENGTH INCH(mm)	AIR INLET INCH	AIR HOSE I.D	AVG. AIR CONSUMPTION cfm(L/min)	NET WEIGHT lb(kg)
KI-3278	1,200	8.4(213)	1/4	3/8	3.9(111)	2.47(1.12)

KI-3270

Positive Clutch

1/4" Hex. Super Duty Air Screwdriver

- Torque range up to 100 in-lb (11.3 Nm)
- Free speed at 2200 rpm
- Smooth trigger and easy slide direction switch
- Ergonomic grip for user comfort
- Premium screwdriver
- Less reaction force
- Ideal for wood screws and self-tapping screws



MODEL	FREE SPEED R. P. M.	OVERALL LENGTH INCH(mm)	AIR INLET INCH	AIR HOSE I.D	AVG. AIR CONSUMPTION cfm(L/min)	NET WEIGHT lb(kg)
KI-3270	2,200	7.1(180)	1/4	3/8	3.9(111)	2.47(1.12)

KI-3274

Positive Clutch

1/4" Hex. Super Duty Air Screwdriver

- Torque range up to 75 in-lb (8.5 Nm)
- Free speed at 3000 rpm
- Ergonomic grip with smooth slide direction switch
- Premium screwdriver with durability
- Speed and productivity
- Ideal for self-tapping and wood screws



MODEL	FREE SPEED R. P. M.	OVERALL LENGTH INCH(mm)	AIR INLET INCH	AIR HOSE I.D	AVG. AIR CONSUMPTION cfm(L/min)	NET WEIGHT lb(kg)
KI-3274	3,000	7.1(180)	1/4	3/8	3.9(111)	2.47(1.12)

SCREWDRIVER

SCREWDRIVER

Externally Adjustable Clutch

SCREWDRIVER

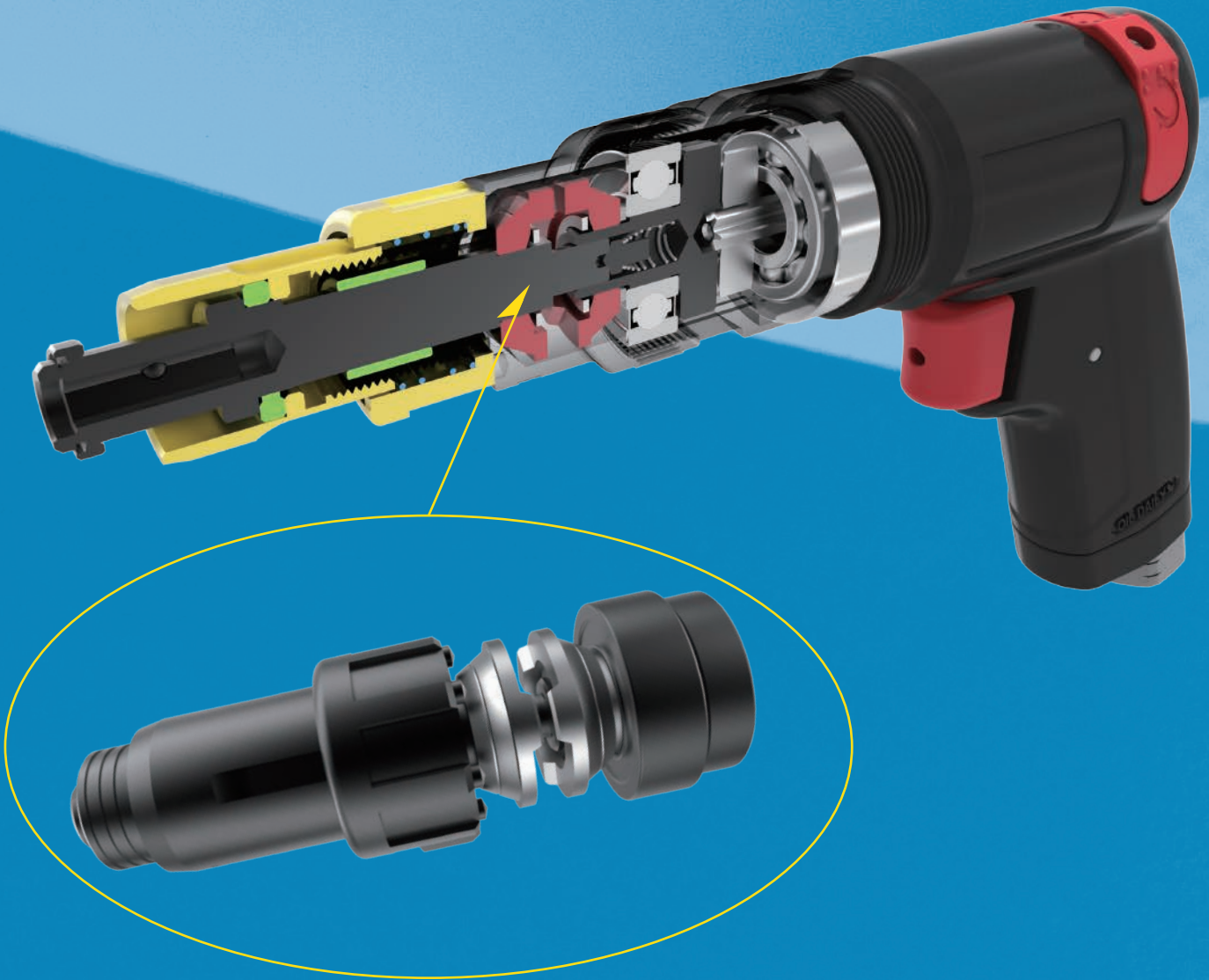

This clutch type is derived from positive clutch design but with a spring in the mechanism for rough torque setting. Torque is set by turning an external torque locator that changes the spring tension and thus alters the torque created by the clutch. The same as the primary Positive clutches, extra torque can be created by operator's force in re-engaging the slipping clutch jaws.

KI-3280

Externally Adjustable Clutch

1/4" Hex. Super Duty Air Screwdriver

- Torque range up to 5-140 in-lb (0.6-15.8 Nm)
- Free speed at 1200 rpm
- Convenient external torque locator
- Well-designed grip, trigger, and slide direction switch
- Precision machined parts for better performance
- Suitable for wide and frequent torque adjustments
- Ideal for wood screws, self-tapping joints, locknuts, and some soft-joint applications



MODEL	FREE SPEED R. P. M.	OVERALL LENGTH INCH(mm)	AIR INLET INCH	AIR HOSE I.D	AVG. AIR CONSUMPTION cfm(L/min)	NET WEIGHT lb(kg)
KI-3280	1,200	9.4(238)	1/4	3/8	3.9(111)	3.29(1.49)

KI-3272

Externally Adjustable Clutch

1/4" Hex. Super Duty Air Screwdriver

- Torque range up to 17-100 in-lb (1.9-11.3 Nm)
- Free speed at 2200 rpm
- Convenient external torque locator
- Ergonomic grip with smooth trigger and slide direction switch
- Premium effective screwdriver
- Wide torque range
- Ideal for wood screws, self-tapping joints, locknuts, and some soft-joint applications



MODEL	FREE SPEED R. P. M.	OVERALL LENGTH INCH(mm)	AIR INLET INCH	AIR HOSE I.D	AVG. AIR CONSUMPTION cfm(L/min)	NET WEIGHT lb(kg)
KI-3272	2,200	8.1(206)	1/4	3/8	3.9(111)	2.60(1.18)

KI-3276

Externally Adjustable Clutch

1/4" Hex. Super Duty Air Screwdriver

- Torque range up to 5-75 in-lb (0.6-8.5 Nm)
- Free speed at 3000 rpm
- Convenient external torque locator
- Ergonomic grip with smooth slide direction switch
- Premium durable screwdriver
- High speed
- Ideal for wood screws, self-tapping joints, locknuts, and some soft-joint applications



MODEL	FREE SPEED R. P. M.	OVERALL LENGTH INCH(mm)	AIR INLET INCH	AIR HOSE I.D	AVG. AIR CONSUMPTION cfm(L/min)	NET WEIGHT lb(kg)
KI-3276	3,000	8.1(206)	1/4	3/8	3.9(111)	2.60(1.18)

SCREWDRIVER

Adjustable Cushion Clutch



Pre-set torque is enabled by adjusting the spring tension. A rolling ball type cam is adopted to disengage the clutch plates when the preset torque is reached. This mechanism avoids excessive fastening forces created by the re-engagement of the isolated plates and therefore gives operator medium control on applied torque.

KI-3279

Adjustable Cushion Clutch

1/4" Hex. Super Duty Air Screwdriver

- Torque range up to 20-140 in-lb (2.3-15.8 Nm)
- Free speed at 1200 rpm
- Smooth slide direction switch
- Ergonomic grip for user comfort
- Premium efficient screwdriver
- Powerful tool with a wide torque range
- Suitable for wood screws, self-tapping screws, sheet metal screws, and locknuts



MODEL	FREE SPEED R. P. M.	OVERALL LENGTH INCH(mm)	AIR INLET INCH	AIR HOSE I.D	AVG. AIR CONSUMPTION cfm(L/min)	NET WEIGHT lb(kg)
KI-3279	1,200	9.3(237)	1/4	3/8	3.9(111)	3.35(1.52)

KI-3271

Adjustable Cushion Clutch

1/4" Hex. Super Duty Air Screwdriver

- Torque range up to 37-100 in-lb (4.2-11.3 Nm)
- Free speed at 2200 rpm
- Well-designed trigger and slide direction switch
- Comfortable and ergonomic grip
- Premium durable screwdriver
- Medium control on the torque output
- Suitable for wood screws, self-tapping screws, sheet metal screws, and locknuts



MODEL	FREE SPEED R. P. M.	OVERALL LENGTH INCH(mm)	AIR INLET INCH	AIR HOSE I.D	AVG. AIR CONSUMPTION cfm(L/min)	NET WEIGHT lb(kg)
KI-3271	2,200	8.3(210)	1/4	3/8	3.6(102)	2.76(1.25)

KI-3275

Adjustable Cushion Clutch

1/4" Hex. Super Duty Air Screwdriver

- Torque range up to 20-75 in-lb (2.3-8.5 Nm)
- Free speed at 3000 rpm
- Ergonomic grip and smooth slide direction switch
- Premium high speed screwdriver
- Flexible torque setting on low torque applications
- Suitable for wood screws, self-tapping screws, sheet metal screws, and locknuts



MODEL	FREE SPEED R. P. M.	OVERALL LENGTH INCH(mm)	AIR INLET INCH	AIR HOSE I.D	AVG. AIR CONSUMPTION cfm(L/min)	NET WEIGHT lb(kg)
KI-3275	3,000	8.3(210)	1/4	3/8	3.9(111)	2.76(1.25)

SCREWDRIVER

Double Trigger Screwdriver



SCREWDRIVER

This series is designed for applications with continuous fastening tasks on a factory assembly line. The Double Trigger design enables the operator to switch between forward and reverse quickly and smoothly by using index and middle fingers. This series is assembled with precision machined parts. The handle housing is made by gravity die casting and is extremely durable in heavy loaded production areas. The top of each wrench is fitted with a ring which makes the tool easy to be hanged on a balancer over the work station. Tools in this series have two air inlets, one on the top end of the handle and the other at the rear. This offers the operator choices of air hose installation to suit their working posture.

• Hanging ring for hooking up the tool

• Long-lasting design
• Suitable for continuous fastening tasks on assembly lines

• Double Trigger design for one handed operation

• 2 air inlets design for convenience

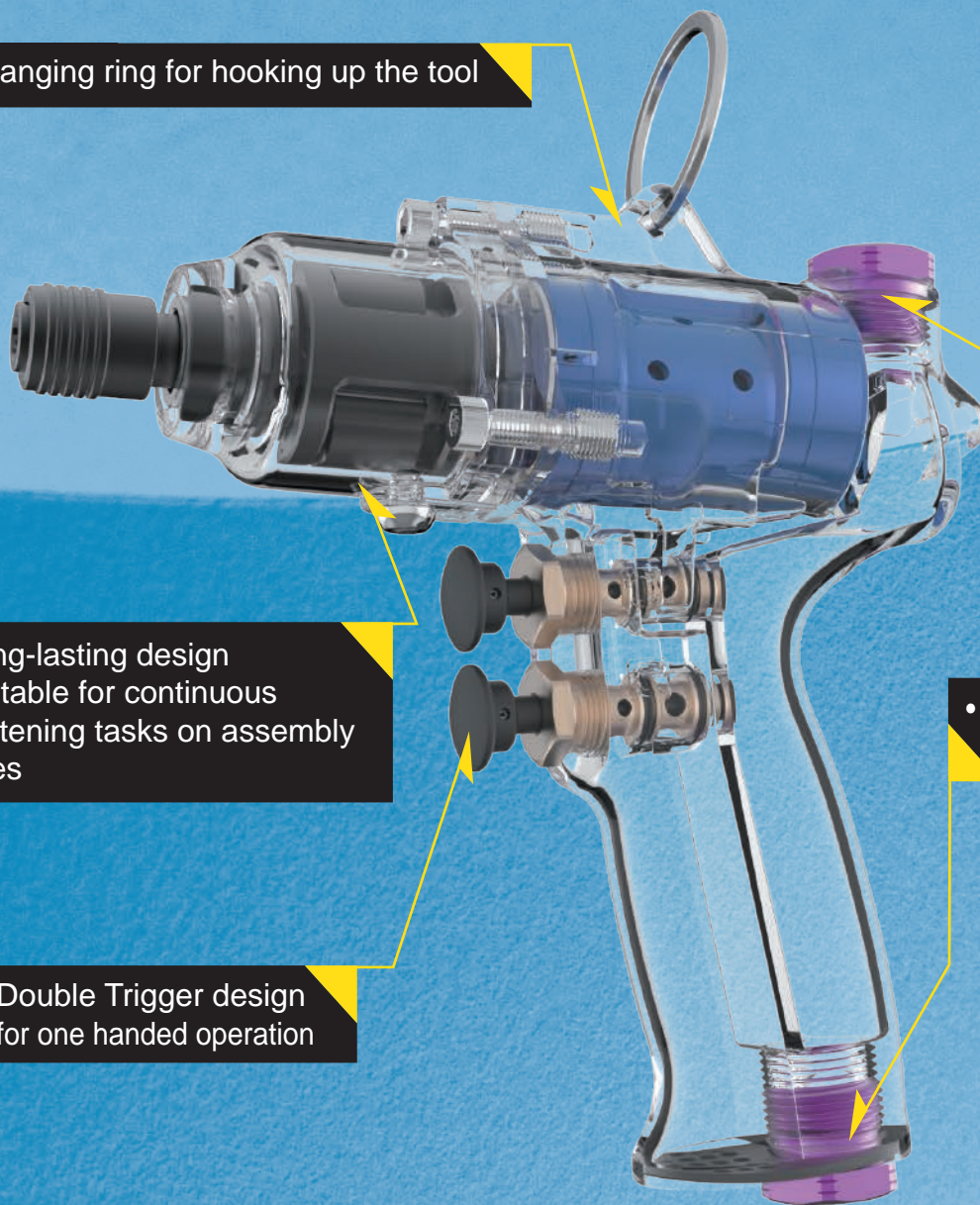

SCREWDRIVER

KI-3266-P-QL

Twin Dog Clutch

1/4" Hex. Super Duty Air Screwdriver

- Max torque of 150 ft-lb with free speed at 8500 rpm
- Mono-power setting, the power is controlled by adjusting the air intake pressure
- Double Trigger for singlehanded direction control
- Pistol tool with a hanging ring
- Smooth increase in torque and less reaction force
- Ideal for high demand assembly lines that require less torque accuracy



MODEL	FREE SPEED R. P. M.	OVERALL LENGTH INCH(mm)	AIR INLET INCH	AIR HOSE I.D	AVG. AIR CONSUMPTION cfm(L/min)	NET WEIGHT lb(kg)
KI-3266-P-QL	8,500	6.9(175)	1/4	3/8	2.5(71)	2.76(1.25)

KI-3290-P-QL

Twin Dog Clutch

1/4" Hex. Super Duty Air Screwdriver

- Max torque of 250 ft-lb with free speed at 8500 rpm
- Mono-power setting, the power is controlled by adjusting the air intake pressure
- Dual air inlet design for different air line arrangement at workstations
- Double Trigger for singlehanded direction control
- Pistol tool with a hanging ring
- Smooth increase in torque and less reaction force
- Ideal for high demand assembly lines that require less torque accuracy



MODEL	FREE SPEED R. P. M.	OVERALL LENGTH INCH(mm)	AIR INLET INCH	AIR HOSE I.D	AVG. AIR CONSUMPTION cfm(L/min)	NET WEIGHT lb(kg)
KI-3290-P-QL	8,500	7.0(177)	1/4	3/8	4.5(127)	1.76(0.80)

KI-3291-P-QL

Twin Dog Clutch

1/4" Hex. Super Duty Air Screwdriver

- Max torque of 350 ft-lb with free speed of 7300 rpm
- Mono power setting, the power is controlled by adjusting the air intake pressure
- Double Trigger for direction control
- Pistol tool with a hanging ring
- Steady increase in torque and less reaction force
- Two air inlets for different air line arrangement at workstation
- Ideal for high demand assembly lines that require less torque accuracy



MODEL	FREE SPEED R. P. M.	OVERALL LENGTH INCH(mm)	AIR INLET INCH	AIR HOSE I.D	AVG. AIR CONSUMPTION cfm(L/min)	NET WEIGHT lb(kg)
KI-3291-P-QL	7,300	6.9(176)	1/4	3/8	2.3(65)	2.49(1.13)

KI-3202-QL

Twin Dog Clutch

1/4" Hex. Super Duty Air Screwdriver

- Max torque of 150 ft-lb with free speed at 8500 rpm
- Mono-power setting, the power is controlled by adjusting the air pressure
- Convenient straight handle with a hanging ring
- Gradually increasing torque with low reaction force
- Ideal for high demand assembly lines that require less torque accuracy



MODEL	FREE SPEED R. P. M.	OVERALL LENGTH INCH(mm)	AIR INLET INCH	AIR HOSE I.D	AVG. AIR CONSUMPTION cfm(L/min)	NET WEIGHT lb(kg)
KI-3202-QL	8,500	8.0(202)	1/4	3/8	2.5(71)	1.98(0.90)

SCREWDRIVER

KI-3202-P-QL

Twin Dog Clutch

1/4" Hex. Super Duty Air Screwdriver

- Max torque of 150 ft-lb with free speed at 8500 rpm
- Mono-power setting, the power is controlled by adjusting the air intake pressure
- Pistol tool with a hanging ring
- The well-balanced clutch enables a gradually increasing torque and low reaction force
- Ideal for high demand assembly lines that require less torque accuracy



MODEL	FREE SPEED R. P. M.	OVERALL LENGTH INCH(mm)	AIR INLET INCH	AIR HOSE I.D	AVG. AIR CONSUMPTION cfm(L/min)	NET WEIGHT lb(kg)
KI-3202-P-QL	8,500	7.6(192)	1/4	3/8	2.5(71)	2.87(1.30)

SCREWDRIVER

KI-3201-QL

Twin Dog Clutch

1/4" Hex. Super Duty Air Screwdriver

Features

- Max torque of 50 ft-lb with fast free speed at 11000 rpm
- Free power setting
- Ergonomic straight handle and lever control

Benefits

- Ideal for high demand assembly lines that require a less torque accuracy



SCREWDRIVER



MODEL	FREE SPEED R. P. M.	OVERALL LENGTH INCH(mm)	AIR INLET INCH	AIR HOSE I.D	AVG. AIR CONSUMPTION cfm(L/min)	NET WEIGHT lb(kg)
KI-3201-QL	11,000	7.5(190)	1/4	3/8	2.5(71)	1.61(0.73)

KI-3238A

Twin Pinless

1/4" Hex. Super Duty Air Screwdriver

Features

- Fast run-down with free speed at 11000 rpm
- Full-caged hammer case well envelops grease for assuring a long-running lubrication and also excellently sustains the clutch assembly
- The cylinder is enhanced by applying heat treatment and increases tool durability

Benefits

- Stable and well-balanced tool performance ensures work efficiency and is designed for high-load assembly line
- Recommended screwdriver capacity: 4.5H (M4, M5)



SCREWDRIVER



MODEL	FREE SPEED R. P.M.	OVERALL LENGTH INCH(mm)	AIR INLET INCH	AIR HOSE I.D	AVG. AIR CONSUMPTION cfm(L/min)	NET WEIGHT lb(kg)
KI-3238A	11,000	7.2(183)	1/4	3/8	2.8(79)	1.81(0.82)

SCREWDRIVER

Classic Screwdriver

For automotive and basic thread fastening tasks, KUANI has screwdrivers of various speeds and torque ranges for general work purposes. While some models are made from typical screwdriver designs, some models are derived from impact wrenches for their fast rundown speeds needed and low reaction force in some applications. KUANI's Classic air screwdrivers aim to give great working efficiency.



SCREWDRIVER

KI-3269-P-QL

Twin Hammer

1/4" Hex. Super Duty Air Screwdriver

Features

- Max reverse torque of 350 ft-lb
- Free speed at 10000 rpm
- Three positive power settings
- Ergonomic composite handle grip
- Well balanced lightweight tool

Benefits

- Ideal for large screws and fasteners



SCREWDRIVER



MODEL	FREE SPEED R. P. M.	OVERALL LENGTH INCH(mm)	AIR INLET INCH	AIR HOSE I.D	AVG. AIR CONSUMPTION cfm(L/min)	NET WEIGHT lb(kg)
KI-3269-P-QL	10,000	6.1(155)	1/4	3/8	4.2(119)	2.87(1.30)

KI-311-JS

Jumbo Hammer

1/4" Hex. Super Duty Air Screwdriver

- Max reverse torque of 200 ft-lb
- Free speed at 10000 rpm
- Five power settings
- Durable aluminum tool
- Ideal for large screws and fasteners



MODEL	FREE SPEED R. P.M.	OVERALL LENGTH INCH(mm)	AIR INLET INCH	AIR HOSE I.D	AVG. AIR CONSUMPTION cfm(L/min)	NET WEIGHT lb(kg)
KI-311-JS	10,000	5.5(140)	1/4	3/8	2.5(71)	2.98(1.35)

SCREWDRIVER

KI-411-JHS

Jumbo Hammer

2 in 1. 1/4" Hex. and 1/2" SQ. DR. Super Duty Air Screwdriver

- Max reverse torque of 200 ft-lb
- Free speed at 10000 rpm
- Five power settings
- Classic aluminum tool with a hanging ring
- Ideal for large screws and fasteners



MODEL	FREE SPEED R. P.M.	OVERALL LENGTH INCH(mm)	AIR INLET INCH	AIR HOSE I.D	AVG. AIR CONSUMPTION cfm(L/min)	NET WEIGHT lb(kg)
KI-411-JHS	10,000	5.5(139)	1/4	3/8	2.5(71)	2.98(1.35)

SCREWDRIVER

KI-3221-QC

Twin Dog Clutch

1/4" Hex. Super Duty Air Screwdriver

Benefits

- Max torque of 80 ft-lb with a free speed of 12,000 rpm
- 3 position power settings
- 180 degree swivel air inlet
- The rocking lever allows single-handed control on both the rotation and power

Benefits

- Improved power to weight ratio
- The shortest tool in its class
- Ideal for general work that needs speed but less torque accuracy



SCREWDRIVER



MODEL	FREE SPEED R. P. M.	OVERALL LENGTH INCH(mm)	AIR INLET INCH	AIR HOSE I.D	AVG. AIR CONSUMPTION cfm(L/min)	NET WEIGHT lb(kg)
KI-3221-QC	12,000	5.7(146)	1/4	3/8	2.1(59)	1.21(0.55)

KI-3211

Adjustable Cushion Clutch

1/4" Hex. Super Duty Air Screwdriver

- Torque range: 45~145 in-lb (5.1~16.4 Nm)
- Free speed at 1800 rpm
- Medium control of torque performance
- Classic aluminum housing with a hanging ring
- Feather light touch lever
- Rotation push button
- Low speed model available: KI-3212 (free speed at 800 rpm)



MODEL	FREE SPEED R. P. M.	OVERALL LENGTH INCH(mm)	AIR INLET INCH	AIR HOSE I.D	AVG. AIR CONSUMPTION cfm(L/min)	NET WEIGHT lb(kg)
KI-3211	1,800	10.4(265)	1/4	3/8	5.0(142)	2.56(1.16)

KI-3213

Externally Adjustable Clutch

1/4" Hex. Super Duty Air Screwdriver

- Torque range: 45~115 in-lb (5.1~13.0 Nm)
- Free speed at 1800 rpm
- Basic control on torque
- Feather light touch lever
- Classic easy direction switch
- Air intake control flexibility



MODEL	FREE SPEED R. P. M.	OVERALL LENGTH INCH(mm)	AIR INLET INCH	AIR HOSE I.D	AVG. AIR CONSUMPTION cfm(L/min)	NET WEIGHT lb(kg)
KI-3213	1,800	10.4(265)	1/4	3/8	3.0(85)	2.56(1.16)

SCREWDRIVER

KI-3215

Adjustable Cushion Clutch

1/4" Hex. Super Duty Air Screwdriver

- Torque range: 20~115 in-lb (2.3~13.0 Nm)
- Free speed at 1800 rpm
- Medium control on torque
- Durable classic aluminum tool
- Easy forward/ reverse toggle switch control
- Low speed model available: KI-3216
- KI-3216 torque range up 45~145 in-lb (5.08 ~16.38 Nm) with free speed at 700 rpm
- Torque range up 45~145 in-lb, or 5.08 ~16.38 Nm, with free speed at 700 rpm



MODEL	FREE SPEED R. P. M.	OVERALL LENGTH INCH(mm)	AIR INLET INCH	AIR HOSE I.D	AVG. AIR CONSUMPTION cfm(L/min)	NET WEIGHT lb(kg)
KI-3215	1,800	8.5(215)	1/4	3/8	3.0(85)	2.65(1.20)

KI-3217

Externally Adjustable Clutch

1/4" Hex. Super Duty Air Screwdriver

- Torque range: 20~115 in-lb (2.3~13.0 Nm)
- Free speed at 1800 rpm
- Basic control on torque
- Durable classic aluminum tool
- Full switch control on activation and direction in the grip



MODEL	FREE SPEED R. P. M.	OVERALL LENGTH INCH(mm)	AIR INLET INCH	AIR HOSE I.D	AVG. AIR CONSUMPTION cfm(L/min)	NET WEIGHT lb(kg)
KI-3217	1,800	8.5(215)	1/4	3/8	3.0(85)	2.71(1.23)

SCREWDRIVER

KI-3220

Positive Clutch Mechanism

1/4" Hex. Super Duty Air Screwdriver

- Torque range: 20~115 in-lb (2.3~13.0 Nm)
- Fast free speed at 1800 rpm
- Extra torque can be reached by re-engaging the clutch jaws
- Classic aluminum tool with a side toggle direction switch
- Full control on the tool in the handle grip
- Ideal for wood applications



MODEL	FREE SPEED R. P. M.	OVERALL LENGTH INCH(mm)	AIR INLET INCH	AIR HOSE I.D	AVG. AIR CONSUMPTION cfm(L/min)	NET WEIGHT lb(kg)
KI-3220	1,800	7.5(190)	1/4	3/8	4.0(113)	2.49(1.13)

SCREWDRIVER

KI-3251

Direct Drive Clutch Mechanism

1/4" Hex. Super Duty Air Screwdriver

- Torque can be up to 70 in-lb (7.9 Nm) under 90 psi
- Free speed at 1800 rpm
- Provides basic fastening capability
- Classic aluminum tool with a side toggle direction switch
- Short and lightweight tool with one hand control
- Ideal for wood applications



MODEL	FREE SPEED R. P. M.	OVERALL LENGTH INCH(mm)	AIR INLET INCH	AIR HOSE I.D	AVG. AIR CONSUMPTION cfm(L/min)	NET WEIGHT lb(kg)
KI-3251	1,800	6.7(170)	1/4	3/8	4.0(113)	2.43(1.10)

SCREWDRIVER

Shut-off Screwdriver



KUANI's shut-off screwdrivers are precise on torque setting and automatically stop upon meeting the preset torque. These tools are designed for the industrial assembly line where critical control on torque is an essential factor. KUANI offer models of varied torque range, speed, start-up type, and handle type, giving a wide choice for the different work conditions and requirements.

To examine the torque accuracy of these shut-off tools the KI-TM-150 (torque tester) is strongly recommended.



Precise Torque Control
• Automatically shut off the air supply upon reaching preset torque

Ergonomic Handle
• Prevents slippage

External Torque Control
• For quick & easy torque adjustment

Accurate Torque Delivery

SCREWDRIVER

Twin Lobe Face Cam Clutch Shut-Off Screwdrivers

Features

- The Twin Lobe Face Cam Clutch is designed with an improved and simplified structure which can prevent from undercutting caused by the parts wearing off over time and ensure long-lasting precision of torque out-put. The simple mechanism also improves the efficiency of maintenance.
- Torque is preset externally.
- To check the preset torque, KI-TM-150 torque tester is strongly recommended.



SCREWDRIVER

Additional Springs for Choice Give more flexibility on Models' torque performance

Clutch Spring Part No.	Free Speed (R. P.M.)		480	800	800
	Torque range		KI-35005-STWA	KI-35008-STWA	KI-34008-STWA
	kgf-cm	N.m	KI-35105-PLWA	KI-35108-PLWA	KI-34108-PLWA
SPR-35005-02-00	20~100	2.0~10.0	Standard		KI-34008-SLWA
SPR-35008-08-00	15~60	1.5~6.0	Optional	Standard	
SPR-35017-03-00	15~35	1.5~3.5	Optional	Optional	
SPR-34021-05-00	8~40	0.8~4.0			Standard
SPR-34021-05-00	10~30	1.0~3.0			
SPR-34021-05-00	10~25	1.0~2.5			
SPR-33017-02-00	10~25	1.0~2.5			
SPR-33017-02-00	10~20	1.0~2.0			
SPR-33023-01-00	10~15	1.0~1.5			

Neutral

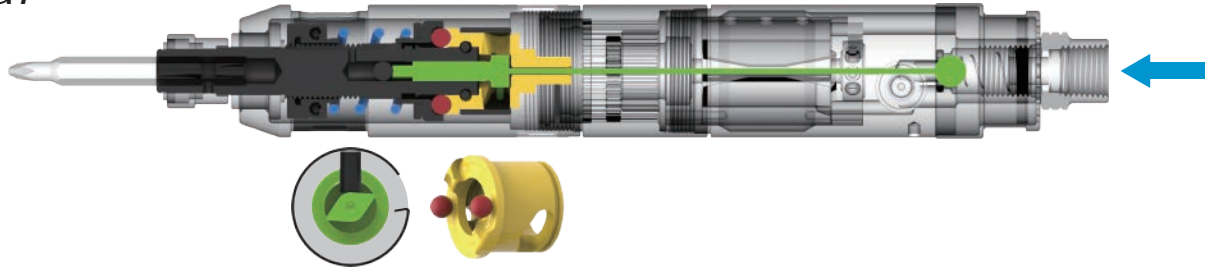

Operation

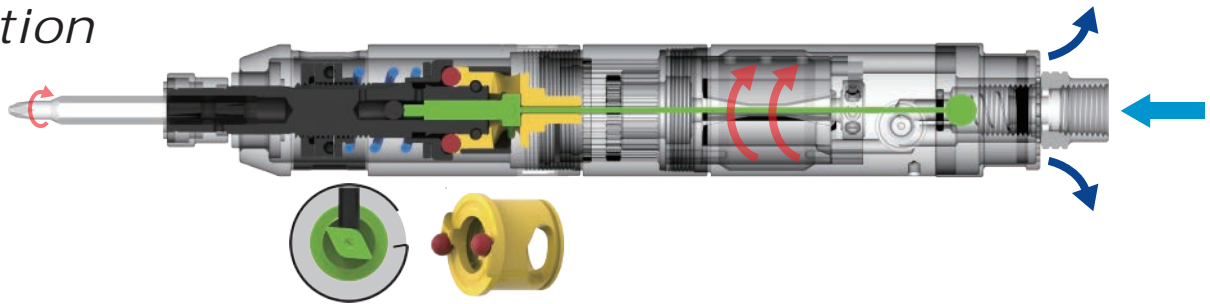

Shut-off

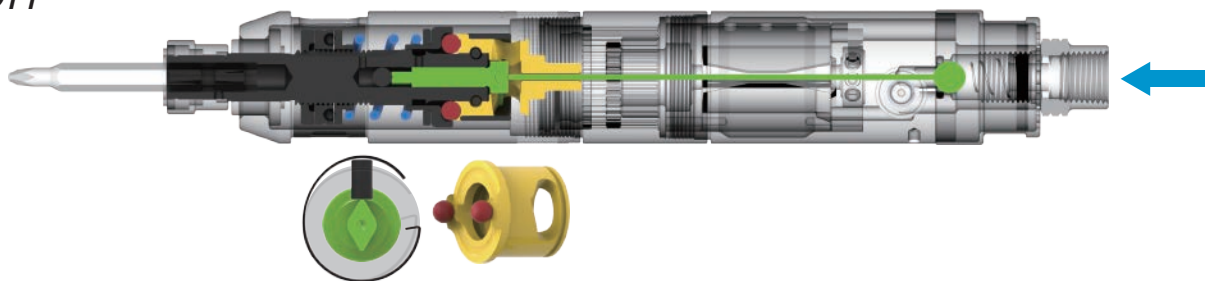

1100	1500	1700	1700	2100	2300
Model No.					
KI-33011-STWA	KI-34015-STWA	KI-35017-STWA	KI-33017-STWA	KI-34021-STWA	KI-33023-STWA
KI-33111-PLWA	KI-34115-PLWA	KI-35117-PLWA	KI-33117-PLWA	KI-34121-PLWA	KI-33123-PLWA
KI-33011-SLWA	KI-34015-SLWA		KI-33017-SLWA	KI-34021-SLWA	KI-33023-SLWA
		Standard			
	Standard				
				Standard	
Standard					
			Standard		
Optional			Optional		Standard

SCREWDRIVER

KI-33006-STWA / KI-33009-STWA / KI-33018-STWA

Shut-off Clutch

1/4" Hex. Super Duty Full-Auto Shut Off Air Screwdriver

Features

- 0.6 inch in handle diameter
- Torque range: 4.4~35.5 in-lb (0.5~4 Nm)
- Three speed for choice: 600, 900, 1800 rpm
- Twin-lobe face cam clutch
- Ring-type direction switch
- Push-to-start (PTS) type

Benefits

- Acute response to preset torque
- Enhanced clutch durability
- Ideal for industrial use



Four coloring ring are attached.
Using variant color ring to identify torque presetting for systemized torque management.



SCREWDRIVER



MODEL	CAPACITY (SCREW SIZE) INCH(mm)	TORQUE RANGE in-lb(Nm)	FREE SPEED R. P. M.	FROM CENTER TO OUTSIDE INCH(mm)	OVERALL LENGTH INCH(mm)	AIR INLET INCH	AIR HOSE I.D.	AVG. AIR CONSUMPTION cfm(L/min)	WEIGHT LESS BIT lb(kg)
KI-33006-STWA	13/64(5)	4.4~35.5(0.5~4)	600	0.6(16.5)	9.7(247)	1/4	1/4	2.1(59)	1.63(0.74)
KI-33009-STWA	5/32(4)	4.4~31(0.5~3.5)	900	0.6(16.5)	9.7(247)	1/4	1/4	2.1(59)	1.68(0.76)
KI-33018-STWA	9/64(3.5)	8.9~26.6(1~3)	1,800	0.6(16.5)	9.7(247)	1/4	1/4	2.1(59)	1.63(0.74)

KI-33011-STWA / KI-33017-STWA / KI-33023-STWA

Shut-off Clutch

1/4" Hex. Super Duty Full-Auto Shut Off Air Screwdriver

Features

- 0.6 inch in handle diameter
- Torque range: 8.8~22 in-lb (1~2.5 Nm)
- Three Free speeds: 1100, 1700, 2300 rpm
- Twin-lobe face cam clutch
- Button direction switch
- Push-to-start (PTS) type

Benefits

- Precise response to the preset torque
- Lightweight tool for less user fatigue



SCREWDRIVER



MODEL	CAPACITY (SCREW SIZE) INCH(mm)	TORQUE RANGE in-lb(Nm)	FREE SPEED R. P. M.	FROM CENTER TO OUTSIDE INCH(mm)	OVERALL LENGTH INCH(mm)	AIR INLET INCH	AIR HOSE I.D.	AVG. AIR CONSUMPTION cfm(L/min)	WEIGHT LESS BIT lb(kg)
KI-33011-STWA	5/32(4)	8.8~22(1~2.5)	1,100	0.6(15.5)	8.4(214)	1/4	1/4	7.1(200)	1.21(0.55)
KI-33017-STWA	5/32(4)	8.8~17.6(1~2)	1,700	0.6(15.5)	8.4(214)	1/4	1/4	7.1(200)	1.21(0.55)
KI-33023-STWA	9/64(3.5)	8.8~13.2(1~1.5)	2,300	0.6(15.5)	8.4(214)	1/4	1/4	7.1(200)	1.21(0.55)

SCREWDRIVER

KI-34008-STWA / KI-34015-STWA / KI-34021-STWA

Shut-off Clutch

1/4" Hex. Super Duty Full-Auto Shut Off Air Screwdriver

Features

- 0.6 inch in handle diameter
- Torque range from 7 to 35.2 in-lb (0.8~4 Nm)
- Three free speeds: 800, 1500, 2100 rpm
- Twin-lobe face cam clutch
- Straight tool with a hanging ring

Benefits

- Immediate stop upon reaching the preset torque
- Models for where slightly more fastening force is needed



SCREWDRIVER



MODEL	CAPACITY (SCREW SIZE) INCH(mm)	TORQUE RANGE in-lb(Nm)	FREE SPEED R. P. M.	FROM CENTER TO OUTSIDE INCH(mm)	OVERALL LENGTH INCH(mm)	AIR INLET INCH	AIR HOSE I.D.	AVG. AIR CONSUMPTION cfm(L/min)	WEIGHT LESS BIT lb(kg)
KI-34008-STWA	13/64(5)	7~35.2(0.8~4)	800	0.6(16.5)	9.2(233)	1/4	1/4	10.6(300)	1.48(0.67)
KI-34015-STWA	13/64(5)	8.8~26.4(1~3)	1,500	0.6(16.5)	9.2(233)	1/4	1/4	10.6(300)	1.48(0.67)
KI-34021-STWA	5/32(4)	8.8~22(1~2.5)	2,100	0.6(16.5)	9.2(233)	1/4	1/4	10.6(300)	1.48(0.67)

KI-35005-STWA / KI-35008-STWA / KI-35017-STWA

Shut-off Clutch

1/4" Hex. Super Duty Full-Auto Shut Off Air Screwdriver

Features

- 0.8 inch in handle diameter
- Torque range from 13.2 to 88 in-lb (1.5~10 Nm)
- Three free speeds: 480, 800, 1700 rpm
- Twin-lobe face cam clutch
- Push-to-start type and a toggle direction switch

Benefits

- Immediate stop when the preset torque is met
- Designed for high fastening force



SCREWDRIVER



MODEL	CAPACITY (SCREW SIZE) INCH(mm)	TORQUE RANGE in-lb(Nm)	FREE SPEED R. P. M.	FROM CENTER TO OUTSIDE INCH(mm)	OVERALL LENGTH INCH(mm)	AIR INLET INCH	AIR HOSE I.D.	AVG. AIR CONSUMPTION cfm(L/min)	WEIGHT LESS BIT lb(kg)
KI-35005-STWA	5/32~15/64(4~6)	17.6~88(2~10)	480	0.8(19.5)	10.1(257)	1/4	3/8	17.7(500)	2.21(1.00)
KI-35008-STWA	5/32~15/64(4~6)	13.2~52.8(1.5~6)	800	0.8(19.5)	10.1(257)	1/4	3/8	17.7(500)	2.21(1.00)
KI-35017-STWA	5/32~13/64(4~5)	13.2~30.8(1.5~3.5)	1,700	0.8(19.5)	10.1(257)	1/4	3/8	17.7(500)	2.21(1.00)

SCREWDRIVER

KI-33011-SLWA / KI-33017-SLWA / KI-33023-SLWA

Shut-off Clutch

1/4" Hex. Super Duty Full-Auto Shut Off Air Screwdriver

Features

- 0.6 inch in handle diameter
- Torque range: 8.8~22 in-lb (1~2.5 Nm)
- Three Free speeds: 1100, 1700, 2300 rpm
- Twin-lobe face cam clutch
- Lever start type and button reverse

Benefits

- Precise response to the preset torque
- Lightweight tool for less user fatigue



SCREWDRIVER



MODEL	CAPACITY (SCREW SIZE) INCH(mm)	TORQUE RANGE in-lb(Nm)	FREE SPEED R. P. M.	FROM CENTER TO OUTSIDE INCH(mm)	OVERALL LENGTH INCH(mm)	AIR INLET INCH	AIR HOSE I.D.	AVG. AIR CONSUMPTION cfm(L/min)	WEIGHT LESS BIT lb(kg)
KI-33011-SLWA	5/32(4)	8.8~22(1~2.5)	1,100	0.6(15.0)	10.3(261)	1/4	1/4	7.1(200)	1.41(0.64)
KI-33017-SLWA	5/32(4)	8.8~17.6(1~2)	1,700	0.6(15.0)	10.3(261)	1/4	1/4	7.1(200)	1.41(0.64)
KI-33023-SLWA	9/64(3.5)	8.8~13.2(1~1.5)	2,300	0.6(15.0)	10.3(261)	1/4	1/4	7.1(200)	1.41(0.64)

KI-34008-SLWA / KI-34015-SLWA / KI-34021-SLWA

Shut-off Clutch

1/4" Hex. Super Duty Full-Auto Shut Off Air Screwdriver

Features

- 0.7 inch in handle diameter
- Torque range: 7~35.2 in-lb (0.8~4 Nm)
- Three Free speeds: 800, 1500, 2100 rpm
- Twin-lobe face cam clutch
- Lever start type and button reverse

Benefits

- Immediate stop upon reaching the preset torque
- Models for where slightly more fastening force is needed



SCREWDRIVER



MODEL	CAPACITY (SCREW SIZE) INCH(mm)	TORQUE RANGE in-lb(Nm)	FREE SPEED R. P. M.	FROM CENTER TO OUTSIDE INCH(mm)	OVERALL LENGTH INCH(mm)	AIR INLET INCH	AIR HOSE I.D.	AVG. AIR CONSUMPTION cfm(L/min)	WEIGHT LESS BIT lb(kg)
KI-34008-SLWA	13/64(5)	7~35.2(0.8~4)	800	0.7(17.0)	10.9(277)	1/4	1/4	10.6(300)	1.68(0.76)
KI-34015-SLWA	13/64(5)	8.8~26.4(1~3)	1,500	0.7(17.0)	10.9(277)	1/4	1/4	10.6(300)	1.68(0.76)
KI-34021-SLWA	5/32(4)	8.8~22(1~2.5)	2,100	0.7(17.0)	10.9(277)	1/4	1/4	10.6(300)	1.68(0.76)

SCREWDRIVER

KI-33111-PLWA / KI-33117-PLWA / KI-33123-PLWA

Shut-off Clutch

1/4" Hex. Super Duty Full-Auto Shut Off Air Screwdriver

Features

- Torque range: 8.8~22 in-lb (1~2.5 Nm)
- Three free speeds: 1100, 1700, and 2300 rpm
- Twin-lobe face cam clutch
- Pistol handle and a side toggle for direction switch

Benefits

- Immediate stop at the preset torque
- Full one hand control on tool activation and direction switch



SCREWDRIVER



MODEL	CAPACITY (SCREW SIZE) INCH(mm)	TORQUE RANGE in-lb(Nm)	FREE SPEED R. P. M.	FROM CENTER TO OUTSIDE INCH(mm)	OVERALL LENGTH INCH(mm)	AIR INLET INCH	AIR HOSE I.D.	AVG. AIR CONSUMPTION cfm(L/min)	WEIGHT LESS BIT lb(kg)
KI-33111-PLWA	5/32(4)	8.8~22(1~2.5)	1,100	0.6(16.0)	7.2(183)	1/4	1/4	7.1(200)	1.63(0.74)
KI-33117-PLWA	5/32(4)	8.8~17.6(1~2)	1,700	0.6(16.0)	7.2(183)	1/4	1/4	7.1(200)	1.63(0.74)
KI-33123-PLWA	9/64(3.5)	8.8~13.2(1~1.5)	2,300	0.6(16.0)	7.2(183)	1/4	1/4	7.1(200)	1.63(0.74)

KI-34108-PLWA / KI-34115-PLWA / KI-34121-PLWA

Shut-off Clutch

1/4" Hex. Super Duty Full-Auto Shut Off Air Screwdriver

Features

- Torque range: 7 to 35.2 in-lb (0.8~4 Nm)
- Three free speeds: 800, 1500, and 2100 rpm
- Twin-lobe face cam clutch
- Pistol handle and a side toggle for direction switch

Benefits

- Immediate stop when the preset torque is reached
- One hand operation



SCREWDRIVER



MODEL	CAPACITY (SCREW SIZE) INCH(mm)	TORQUE RANGE in-lb(Nm)	FREE SPEED R. P. M.	FROM CENTER TO OUTSIDE INCH(mm)	OVERALL LENGTH INCH(mm)	AIR INLET INCH	AIR HOSE I.D.	AVG. AIR CONSUMPTION cfm(L/min)	WEIGHT LESS BIT lb(kg)
KI-34108-PLWA	13/64(5)	7~35.2(0.8~4)	800	0.7(17.0)	7.6(194)	1/4	1/4	10.6(300)	1.92(0.87)
KI-34115-PLWA	13/64(5)	8.8~26.4(1~3)	1,500	0.7(17.0)	7.6(194)	1/4	1/4	10.6(300)	1.92(0.87)
KI-34121-PLWA	5/32(4)	8.8~22(1~2.5)	2,100	0.7(17.0)	7.6(194)	1/4	1/4	10.6(300)	1.92(0.87)

SCREWDRIVER

KI-35105-PLWA / KI-35108-PLWA / KI-35117-PLWA

Shut-off Clutch

1/4" Hex. Super Duty Full-Auto Shut Off Air Screwdriver

Features

- Torque range from 13.2 to 88 in-lb (1.5~10 Nm)
- Three free speeds: 480, 800, 1700 rpm
- Twin-lobe face cam clutch
- Pistol handle and a side toggle direction switch

Benefits

- Models of high fastening torque
- Full one hand control on tool activation and direction switch



SCREWDRIVER



MODEL	CAPACITY (SCREW SIZE) INCH(mm)	TORQUE RANGE in-lb(Nm)	FREE SPEED R. P. M.	FROM CENTER TO OUTSIDE INCH(mm)	OVERALL LENGTH INCH(mm)	AIR INLET INCH	AIR HOSE I.D.	AVG. AIR CONSUMPTION cfm(L/min)	WEIGHT LESS BIT lb(kg)
KI-35105-PLWA	5/32~15/64(4~6)	17.6~88(2~10)	480	0.8(20.0)	8.4(213)	1/4	3/8	17.7(500)	2.65(1.20)
KI-35108-PLWA	5/32~15/64(4~6)	13.2~52.8(1.5~6)	800	0.8(20.0)	8.4(213)	1/4	3/8	17.7(500)	2.65(1.20)
KI-35117-PLWA	5/32~13/64(4~5)	13.2~30.8(1.5~3.5)	1,700	0.8(20.0)	8.4(213)	1/4	3/8	17.7(500)	2.65(1.20)

NOTE

Lined area for notes with 22 horizontal grey bars.

SCREWDRIVER

Quad Camshaft Clutch Shut-Off Screwdrivers

Features

- The Quad Camshaft Clutch is one of Classic shut-off clutch mechanisms, which is widely applied in Asia.
- Torque is set externally.
- To check the preset torque, KI-TM-150 torque tester is strongly recommended.



SCREWDRIVER

Additional Springs for Choice Give more flexibility on Models' torque performance

Clutch Spring Part No.	Free Speed (R. P.M.)		480	800	800
	Torque range		KI-35005-STUA	KI-35008-STUA	KI-34008-STUA
	kgf-cm	N.m	KI-35105-PLUA	KI-35108-PLUA	KI-34108-PLUA
SPR-35005-01-00	50~105	5.0~10.5	Standard		KI-34008-SLUA
SPR-35008-06-00	30~55	3.0~5.5	Optional	Standard	
SPR-35017-02-00	15~26	1.5~2.6	Optional	Optional	
SPR-34008-01-00	16~40	1.6~4.0			Standard
SPR-34015-01-00	10~22	1.0~2.2			Optional
SPR-34021-03-00	10~17	1.0~1.7			Optional
SPR-33011-01-00	11~21	1.1~2.1			
SPR-33017-02-00	7~15	0.7~1.5			
SPR-33023-01-00	4~10	0.4~1.0			

Neutral

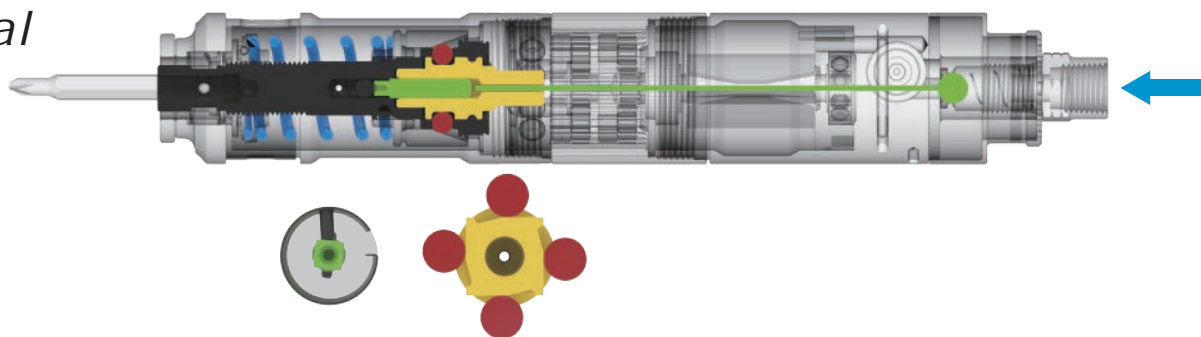

Operation

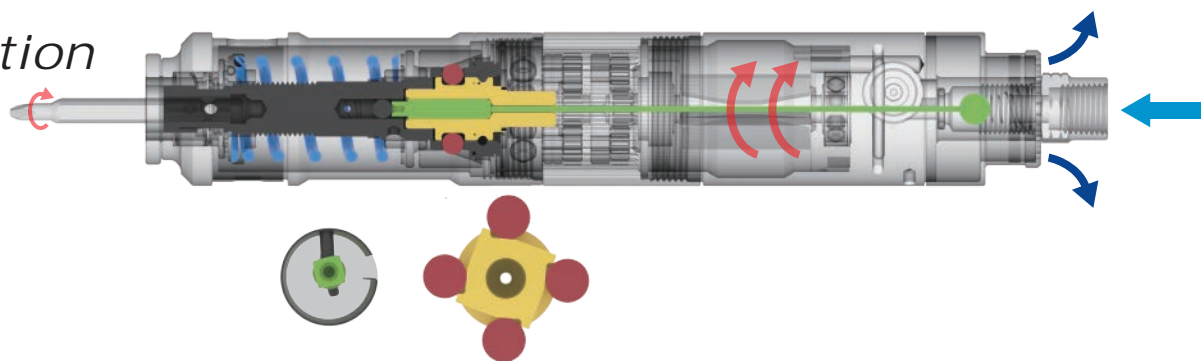

Shut-off

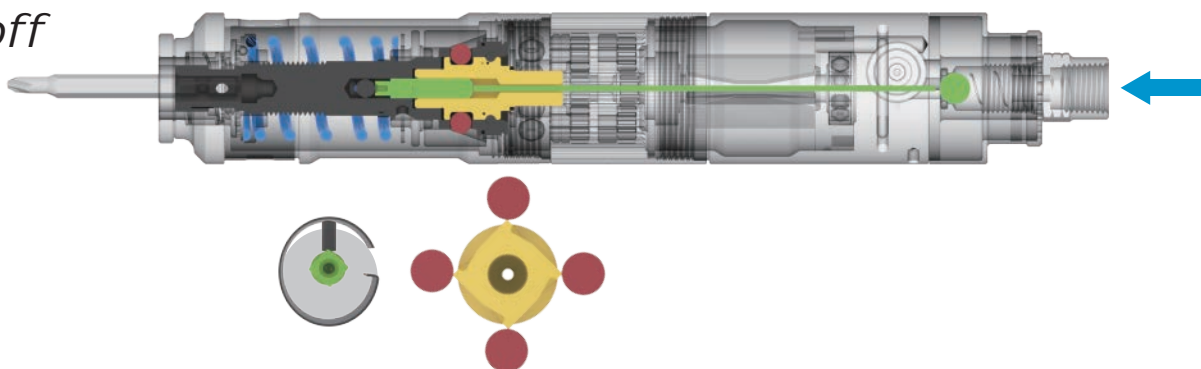

1100	1500	1700	1700	2100	2300
Model No.					
KI-33011-STUA	KI-34015-STUA	KI-35017-STUA	KI-33017-STUA	KI-34021-STUA	KI-33023-STUA
KI-33111-PLUA	KI-34115-PLUA	KI-35117-PLUA	KI-33117-PLUA	KI-34121-PLUA	KI-33123-PLUA
KI-33011-SLUA	KI-34015-SLUA		KI-33017-SLUA	KI-34021-SLUA	KI-33023-SLUA
		Standard			
	Standard				
	Optional			Standard	
Standard					
Optional			Standard		
Optional			Optional		Standard

SCREWDRIVER

KI-33011-STUA / KI-33017-STUA / KI-33023-STUA

Shut-off Clutch

1/4" Hex. Super Duty Full-Auto Shut Off Air Screwdriver

Features

- 0.6 inch in handle diameter
- Torque range: 3.5~18.5 in-lb (0.4~2.1 Nm)
- Three Free speeds: 1100, 1700, 2300 rpm
- Clutch with rolling-ball quad camshaft
- Button direction switch
- Push-to-start (PTS) type

Benefits

- Precise response to the preset torque
- Lightweight tool for less user fatigue

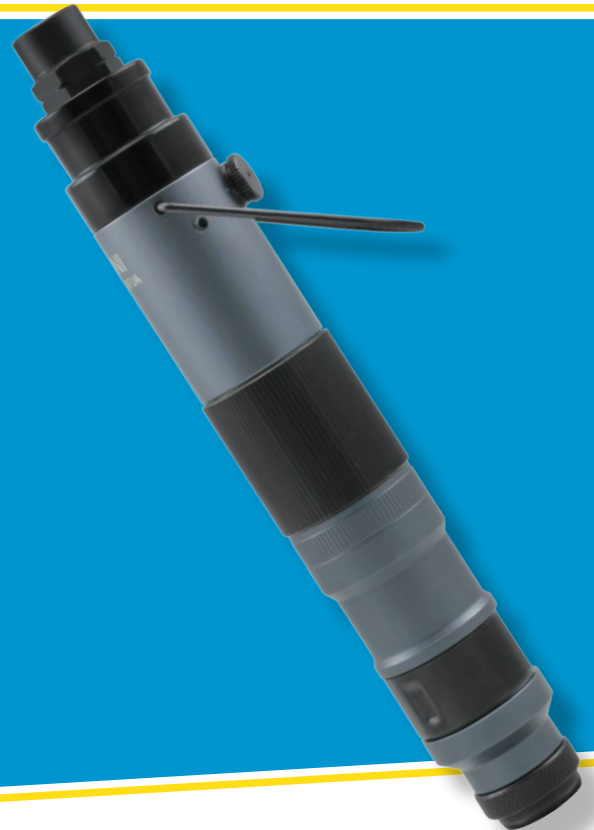

SCREWDRIVER



MODEL	CAPACITY (SCREW SIZE) INCH(mm)	TORQUE RANGE in-lb(Nm)	FREE SPEED R. P. M.	FROM CENTER TO OUTSIDE INCH(mm)	OVERALL LENGTH INCH(mm)	AIR INLET INCH	AIR HOSE I.D.	AVG. AIR CONSUMPTION cfm(L/min)	WEIGHT LESS BIT lb(kg)
KI-33011-STUA	5/32(4)	9.7~18.5(1.1~2.1)	1,100	0.6(15.5)	7.4(187)	1/4	1/4	7.0(198)	0.95(0.43)
KI-33017-STUA	9/64(3.5)	6.2~13.2(0.7~1.5)	1,700	0.6(15.5)	7.4(187)	1/4	1/4	7.0(198)	0.95(0.43)
KI-33023-STUA	1/8(3)	3.5~8.8(0.4~1)	2,300	0.6(15.5)	7.4(187)	1/4	1/4	7.0(198)	0.95(0.43)

KI-34008-STUA / KI-34015-STUA / KI-34021-STUA

Shut-off Clutch

1/4" Hex. Super Duty Full-Auto Shut Off Air Screwdriver

Features

- 0.6 inch in handle diameter
- Torque range from 8.8 to 35.2 in-lb (1~4 Nm)
- Three free speeds: 800, 1500, 2100 rpm
- Clutch with rolling-ball quad camshaft
- Straight tool with a handing ring

Benefits

- Immediate stop upon reaching the preset torque
- Models for where slightly more fastening force is needed



SCREWDRIVER



MODEL	CAPACITY (SCREW SIZE) INCH(mm)	TORQUE RANGE in-lb(Nm)	FREE SPEED R. P. M.	FROM CENTER TO OUTSIDE INCH(mm)	OVERALL LENGTH INCH(mm)	AIR INLET INCH	AIR HOSE I.D.	AVG. AIR CONSUMPTION cfm(L/min)	WEIGHT LESS BIT lb(kg)
KI-34008-STUA	13/64(5)	14.1~35.2(1.6~4)	800	0.6(16.5)	8.2(209)	1/4	1/4	10.5(297)	1.43(0.65)
KI-34015-STUA	5/32(4)	8.8~19.4(1~2.2)	1,500	0.6(16.5)	8.2(209)	1/4	1/4	10.5(297)	1.43(0.65)
KI-34021-STUA	5/32(4)	8.8~13.2(1~1.7)	2,100	0.6(16.5)	8.2(209)	1/4	1/4	10.5(297)	1.43(0.65)

SCREWDRIVER

KI-35005-STUA / KI-35008-STUA / KI-35017-STUA

Shut-off Clutch

1/4" Hex. Super Duty Full-Auto Shut Off Air Screwdriver

Features

- 0.8 inch in handle diameter
- Torque range from 13.2 to 92.4 in-lb (1.5~10.5 Nm)
- Three free speeds: 480, 800, 1700 rpm
- Clutch with rolling-ball quad camshaft
- Push-to-start type and a toggle direction switch

Benefits

- Immediate stop when the preset torque is met
- Designed for high fastening force

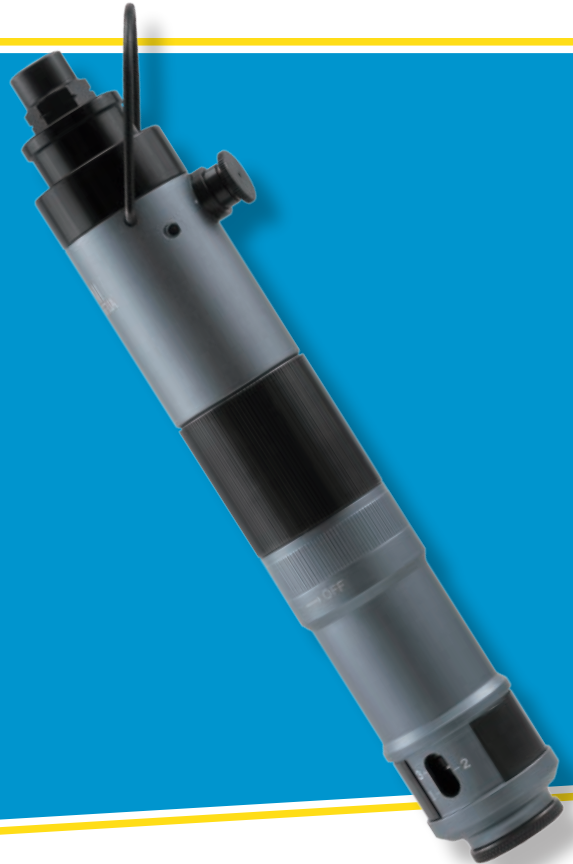

SCREWDRIVER



MODEL	CAPACITY (SCREW SIZE) INCH(mm)	TORQUE RANGE in-lb(Nm)	FREE SPEED R. P. M.	FROM CENTER TO OUTSIDE INCH(mm)	OVERALL LENGTH INCH(mm)	AIR INLET INCH	AIR HOSE I.D.	AVG. AIR CONSUMPTION cfm(L/min)	WEIGHT LESS BIT lb(kg)
KI-35005-STUA	13/64~15/64(5~6)	44~92.4(5~10.5)	480	0.8(19.5)	9.4(240)	1/4	3/8	17.5(496)	2.21(1.00)
KI-35008-STUA	13/64~15/64(5~6)	26.4~48.4(3~5.5)	800	0.8(19.5)	9.4(240)	1/4	3/8	17.5(496)	2.21(1.00)
KI-35017-STUA	5/32~13/64(4~5)	13.2~23(1.5~2.6)	1,700	0.8(19.5)	9.4(240)	1/4	3/8	17.5(496)	2.21(1.00)

KI-33011-SLUA / KI-33017-SLUA / KI-33023-SLUA

Shut-off Clutch

1/4" Hex. Super Duty Full-Auto Shut Off Air Screwdriver

Features

- 0.6 inch in handle diameter
- Torque range: 3.5~18.5 in-lb (0.4~2.1 Nm)
- Three free speeds: 1100, 1700, and 2300 rpm
- Clutch with rolling-ball quad camshaft
- Lever start type and button reverse

Benefits

- Reliable tool for achieving precise fastening force



SCREWDRIVER



MODEL	CAPACITY (SCREW SIZE) INCH(mm)	TORQUE RANGE in-lb(Nm)	FREE SPEED R. P. M.	FROM CENTER TO OUTSIDE INCH(mm)	OVERALL LENGTH INCH(mm)	AIR INLET INCH	AIR HOSE I.D.	AVG. AIR CONSUMPTION cfm(L/min)	WEIGHT LESS BIT lb(kg)
KI-33011-SLUA	9/64(3.5)	9.7~18.5(1.1~2.1)	1,100	0.6(15.0)	9.0(229)	1/4	1/4	7.0(198)	1.17(0.53)
KI-33017-SLUA	9/64(3.5)	6.2~13.2(0.7~1.5)	1,700	0.6(15.0)	9.0(229)	1/4	1/4	7.0(198)	1.17(0.53)
KI-33023-SLUA	1/8(3)	3.5~8.8(0.4~1)	2,300	0.6(15.0)	9.0(229)	1/4	1/4	7.0(198)	1.17(0.53)

SCREWDRIVER

KI-34008-SLUA / KI-34015-SLUA / KI-34021-SLUA

Shut-off Clutch

1/4" Hex. Super Duty Full-Auto Shut Off Air Screwdriver

Features

- 0.7 inch in handle diameter
- Torque range: 8.8 to 35.2 in-lb (1~4 Nm)
- Three free speeds: 800, 1500, and 2100 rpm
- Clutch with rolling-ball quad camshaft
- Lever start type and button reverse

Benefits

- Models for a higher fastening torque
- Immediate stop when reaching preset torque



SCREWDRIVER



MODEL	CAPACITY (SCREW SIZE) INCH(mm)	TORQUE RANGE in-lb(Nm)	FREE SPEED R. P. M.	FROM CENTER TO OUTSIDE INCH(mm)	OVERALL LENGTH INCH(mm)	AIR INLET INCH	AIR HOSE I.D.	AVG. AIR CONSUMPTION cfm(L/min)	WEIGHT LESS BIT lb(kg)
KI-34008-SLUA	13/64(5)	14.1~35.2(1.6~4)	800	0.7(17.0)	9.8(249)	1/4	1/4	10.5(297)	1.54(0.70)
KI-34015-SLUA	5/32(4)	8.8~19.4(1~2.2)	1,500	0.7(17.0)	9.8(249)	1/4	1/4	10.5(297)	1.54(0.70)
KI-34021-SLUA	5/32(4)	8.8~13.2(1~1.7)	2,100	0.7(17.0)	9.8(249)	1/4	1/4	10.5(297)	1.54(0.70)

KI-33111-PLUA / KI-33117-PLUA / KI-33123-PLUA

Shut-off Clutch

1/4" Hex. Super Duty Full-Auto Shut Off Air Screwdriver

Features

- Torque range: 3.5~18.5 in-lb (0.4~2.1 Nm)
- Three free speeds: 1100, 1700, and 2300 rpm
- Clutch of rolling-ball quad camshaft
- Pistol handle and a side toggle for direction switch

Benefits

- Immediate stop at the preset torque
- Full one hand control on tool activation and direction switch



SCREWDRIVER



MODEL	CAPACITY (SCREW SIZE) INCH(mm)	TORQUE RANGE in-lb(Nm)	FREE SPEED R. P. M.	FROM CENTER TO OUTSIDE INCH(mm)	OVERALL LENGTH INCH(mm)	AIR INLET INCH	AIR HOSE I.D.	AVG. AIR CONSUMPTION cfm(L/min)	WEIGHT LESS BIT lb(kg)
KI-33111-PLUA	7/64(2.6)	9.7~18.5(1.1~2.1)	1,100	0.6(16.0)	6.7(170)	1/4	1/4	7.0(198)	1.57(0.71)
KI-33117-PLUA	3/32(2.2)	6.2~13.2(0.7~1.5)	1,700	0.6(16.0)	6.7(170)	1/4	1/4	7.0(198)	1.57(0.71)
KI-33123-PLUA	7/64(2.6)	3.5~8.8(0.4~1)	2,300	0.6(16.0)	6.7(170)	1/4	1/4	7.0(198)	1.57(0.71)

SCREWDRIVER

KI-34108-PLUA / KI-34115-PLUA / KI-34121-PLUA

Shut-off Clutch

1/4" Hex. Super Duty Full-Auto Shut Off Air Screwdriver

Features

- Torque range: 8.8 to 35.2 in-lb (1~4 Nm)
- Three free speeds: 800, 1500, and 2100 rpm
- Clutch of rolling-ball quad camshaft
- Pistol handle and a side toggle for direction switch

Benefits

- Immediate stop when the preset torque is reached
- One hand operation



SCREWDRIVER



MODEL	CAPACITY (SCREW SIZE) INCH(mm)	TORQUE RANGE in-lb(Nm)	FREE SPEED R. P. M.	FROM CENTER TO OUTSIDE INCH(mm)	OVERALL LENGTH INCH(mm)	AIR INLET INCH	AIR HOSE I.D.	AVG. AIR CONSUMPTION cfm(L/min)	WEIGHT LESS BIT lb(kg)
KI-34108-PLUA	5/32(4)	14.1~35.2(1.6~4)	800	0.7(17.0)	6.9(175)	1/4	1/4	10.5(297)	1.92(0.87)
KI-34115-PLUA	9/64(3.5)	8.8~19.4(1~2.2)	1,500	0.7(17.0)	6.9(175)	1/4	1/4	10.5(297)	1.92(0.87)
KI-34121-PLUA	1/8(3)	8.8~13.2(1~1.7)	2,100	0.7(17.0)	6.9(175)	1/4	1/4	10.5(297)	1.92(0.87)

KI-35105-PLUA / KI-35108-PLUA / KI-35117-PLUA

Shut-off Clutch

1/4" Hex. Super Duty Full-Auto Shut Off Air Screwdriver

Features

- Torque range from 13.2 to 92.4 in-lb (1.5~10.5 Nm)
- Three free speeds: 480, 800, 1700 rpm
- Clutch of a rolling-ball quad camshaft
- Pistol handle and a side toggle direction switch

Benefits

- Models of high fastening torque
- Full one hand control on tool activation and direction switch



SCREWDRIVER



MODEL	CAPACITY (SCREW SIZE) INCH(mm)	TORQUE RANGE in-lb(Nm)	FREE SPEED R. P. M.	FROM CENTER TO OUTSIDE INCH(mm)	OVERALL LENGTH INCH(mm)	AIR INLET INCH	AIR HOSE I.D.	AVG. AIR CONSUMPTION cfm(L/min)	WEIGHT LESS BIT lb(kg)
KI-35105-PLUA	13/64(5)	44~92.4(5~10.5)	480	0.8(20.0)	7.8(198)	1/4	3/8	17.5(496)	2.65(1.20)
KI-35108-PLUA	5/32(4)	26.4~48.4(3~5.5)	800	0.8(20.0)	7.8(198)	1/4	3/8	17.5(496)	2.65(1.20)
KI-35117-PLUA	5/32(4)	13.2~23(1.5~2.6)	1,700	0.8(20.0)	7.8(198)	1/4	3/8	17.5(496)	2.65(1.20)

SCREWDRIVER

Shut-off Nut Runner



SCREWDRIVER

Shut-off nut runners, commonly known as an angle wrench or angle screwdriver elsewhere are now new in KUANI's product portfolio. Advantageous in torque controllability and accessibility, these tools are ideal for an assembly line where more than one screw is manually fastened in a product. KUANI's shut-off nut runners have an accurate response to the preset torque, meeting needs of highly demanding fastening tasks.

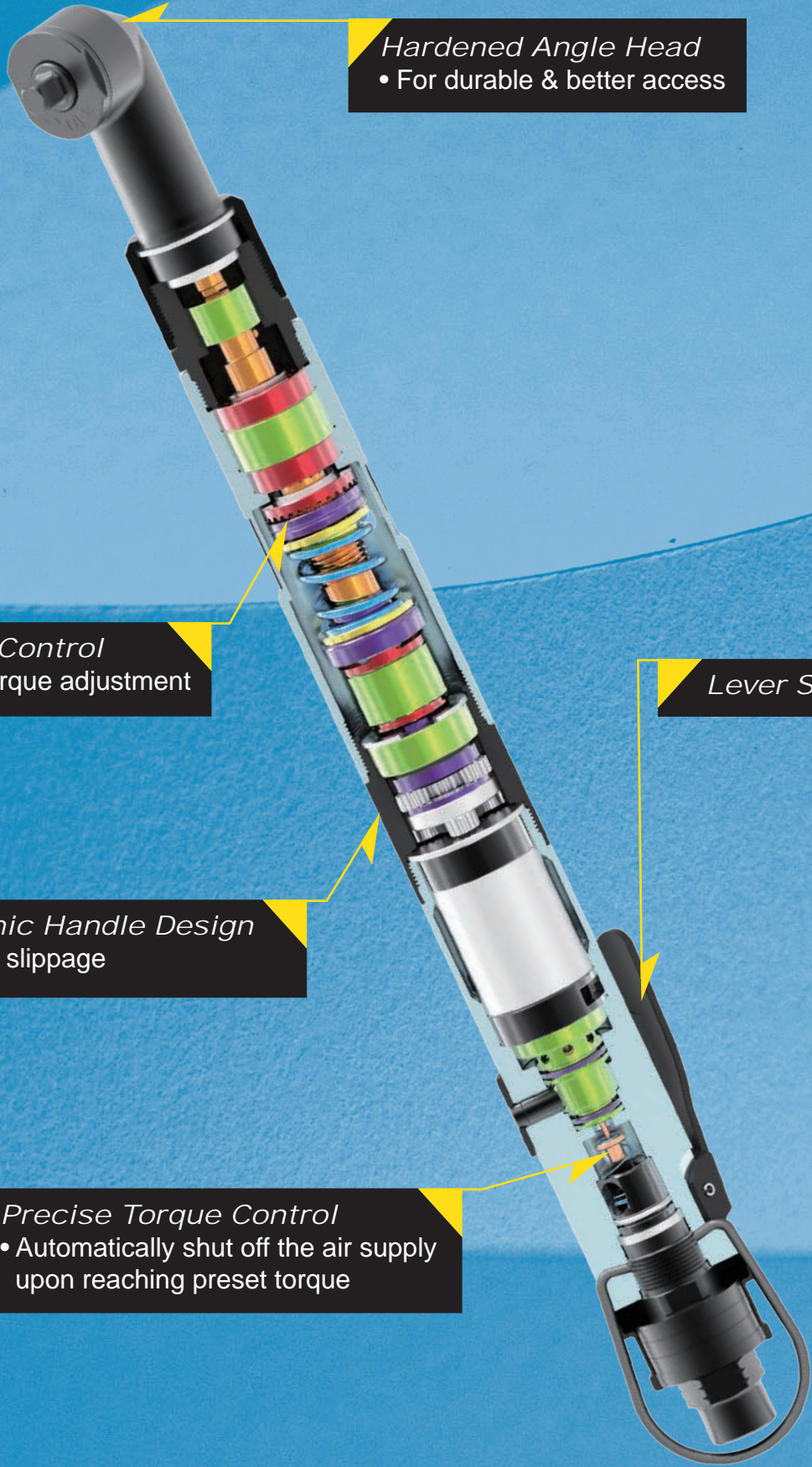

Hardened Angle Head
• For durable & better access

External Torque Control
• For quick & easy torque adjustment

Ergonomic Handle Design
• Prevents slippage

Precise Torque Control
• Automatically shut off the air supply upon reaching preset torque

Lever Start

SCREWDRIVER

KI-34003-CGWC / KI-34003-CGWD

Shut-off Clutch

1/4" SQ. DR. Super Duty Full-Auto Shut Off Air Nut Runner

Features

- Twin-lobe face cam clutch
- Can be suspended over work area by attaching a hanging ring
- Lever start
- Slide-ring type F/R switch

Benefits

- Enhanced clutch durability
- Acute response to preset torque
- For tasks needing frequent change in operation direction
- Designed for industrial applications

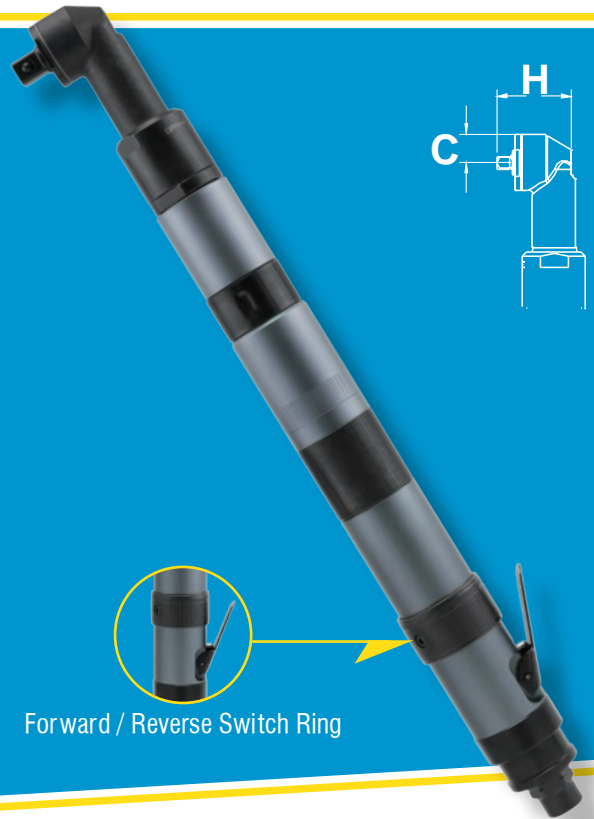

Forward / Reverse Switch Ring

SCREWDRIVER



MODEL	SQUARE DRIVER INCH	CAPACITY (SCREW SIZE) INCH(mm)	TORQUE RANGE in-lb(Nm)	FREE SPEED R. P.M.	FROM CENTER TO OUTSIDE INCH(mm)	OVERALL LENGTH INCH(mm)	HEAD SIZE C INCH(mm) H INCH(mm)		AIR INLET INCH	AIR HOSE I.D	AVG. AIR CONSUMPTION cfm(L/min)	WEIGHT LESS BIT lb(kg)
34003-CGWC	1/4	5/32(4)	17.6~92.4(2~10.5)	300	0.7(17.8)	14.5(368)	0.5(13.0)	1.4(35.5)	1/4	1/4	3.5(99)	2.43(1.10)
34003-CGWD	3/8	5/32(4)	17.6~92.4(2~10.5)	300	0.7(17.8)	14.5(368)	0.5(13.0)	1.6(40.5)	1/4	1/4	3.5(99)	2.43(1.10)

KI-34003-CLWC / KI-34003-CLWD

Shut-off Clutch

1/4" SQ. DR. Super Duty Full-Auto Shut Off Air Nut Runner

Features

- Twin-lobe face cam clutch
- Can be suspended over work area by attaching a hanging ring
- Lever start
- Button type F/R switch lock

Benefits

- Enhanced clutch durability
- Precise torque-control for high demand production lines
- For constant one-way fastening tasks
- Ideal for industrial applications

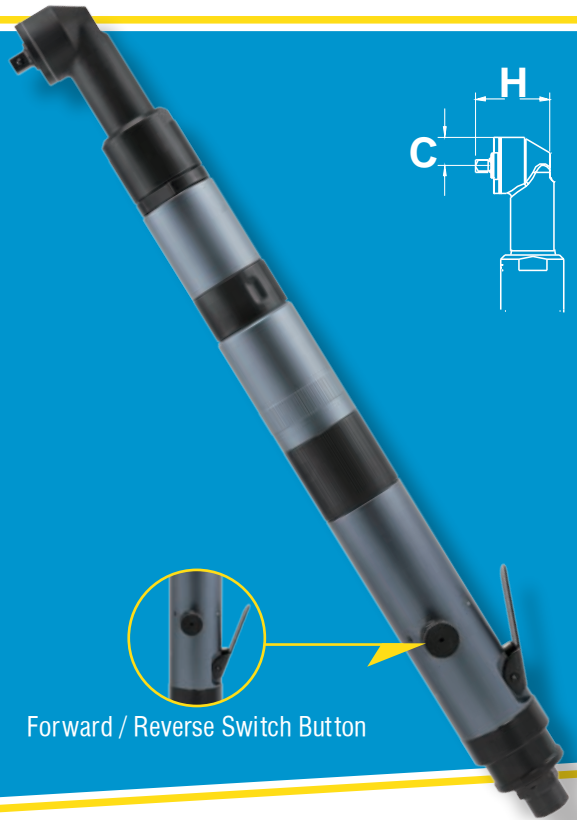

Forward / Reverse Switch Button

SCREWDRIVER



MODEL	SQUARE DRIVER INCH	CAPACITY (SCREW SIZE) INCH(mm)	TORQUE RANGE in-lb(Nm)	FREE SPEED R. P.M.	FROM CENTER TO OUTSIDE INCH(mm)	OVERALL LENGTH INCH(mm)	HEAD SIZE		AIR INLET INCH	AIR HOSE I.D	AVG. AIR CONSUMPTION cfm(L/min)	WEIGHT LESS BIT lb(kg)
							C	H				
34003-CLWC	1/4	5/32(4)	17.6~92.4(2~10.5)	300	0.7(17.8)	14.5(368)	0.5(13.0)	1.4(35.5)	1/4	1/4	3.5(99)	2.43(1.10)
34003-CLWD	3/8	5/32(4)	17.6~92.4(2~10.5)	300	0.7(17.8)	14.5(368)	0.5(13.0)	1.6(40.5)	1/4	1/4	3.5(99)	2.43(1.10)

SCREWDRIVER

Torque Tester

Suitable for Shut-off Screwdriver Torque Testing
 Testing Range: 0.5-15 Nm

- LCD display with backlight function.
- Peak and tracing mode selectable.

- High-/Low-limits setting and detection.
- Color LEDs indication for pass and fail.

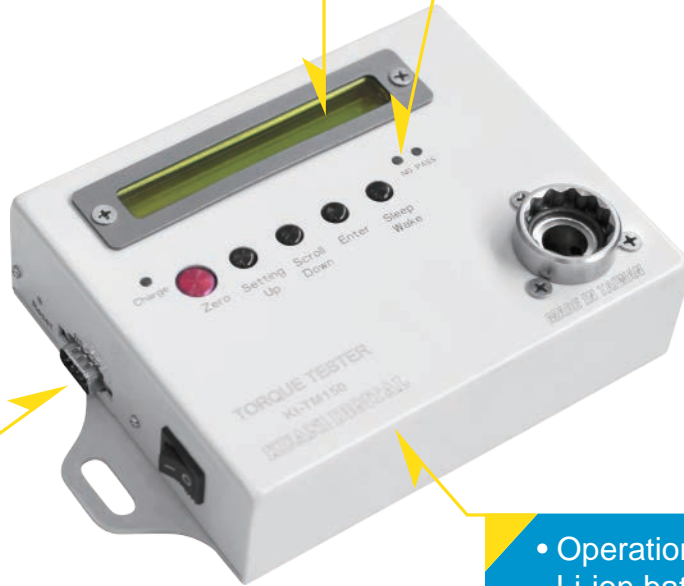

- RS232 serial bus connection to a PC.
- Automatic test report generation available.

- Operation from internal rechargeable Li-ion battery pack or a.c. supply (100-240Volts).

KI-TM-150 includes

- DC 7.5V/0.8A Changer 1PC
- RS-232 Cable 1PC
- Software on CD-R 1PC
- Soft Joint Simulator-Set 1: for target torque $\geq 5\text{N.m}$ (51.0 Kg-cm) 1PC
- Soft Joint Simulator-Set 2: for target torque $< 5\text{N.m}$ (51.0 Kg-cm) 1PC



Specifications Recommended Air Pressure at 90 psi (6.2bar)

MODEL	MEASUREMENT RANGE N-m	DIMENSION mm	ACCURACY %	NET WEIGHT kg
KI-TM-150	0.5~15	215x134x60	+/-1	1.3

Specification and Features of KI-TM-150

Measurement Range	0.5~15 N-m
Display	5 effective digits max.
Static Accuracy	±1% tolerance of reading
Unit of Measurement	Kg-cm, N-m, Lb-in , Lb-ft
Operating Temperature Range	+5° C ~+40° C
Storage Temperature Range	0° C ~ +50° C
Operating Humidity	25~85 % RH
Power Supply	100~240 Volt a.c. at 50-60 Hz input
Power Consumption	Less than 1.5 W
Power Cable	1800mm
Base Material	Metal
Dimension	215mm x 134mm x 60mm
PC Connection	RS-232
Net Weight	1.3 Kg

- 2 Memory/Measure modes:

Track mode: will display the reading in real time when torque is applied to the fastener. For use with manual, electric, pneumatic, and cordless torque controlled tools (not for use with impact tools).

Peak mode: allows the wrench to read the maximum torque applied to the fastener. For use with dial or electronic torque wrenches.

- 4 available measurement units: **Kg-cm, N-m, Lb-in, Lb-ft**

- Indications of testing result:

The KI-TM-150 allows the user to set the target torque and the upper/lower tolerance limits.

Pass: When the test result is within the tolerance setting, the Green-light will be on.

NG: When the test result is out of tolerance, the Red-light will be on, which represents the test was failed. The user shall adjust the torque nut of screwdriver and try again until pass test (i.e. the Green-light is on).

- Soft-joint rundown fixtures:

The KI-TM-150 comes with 2 soft-joint rundown fixtures:

The light rundown unit (LHS) is for measuring target torque **under 50 Kg-cm**;

The heavy rundown unit (RHS) is for measuring target torque set at **50 kg-cm and above**.



Light Rundown Unit



Heavy Rundown Unit

INDEX

Index Sequenced by Torque Range > Free Speed > Overall Length

MODEL	PAGE	TORQUE RANGE in-lb(Nm)	FREE SPEED R. P. M.	OVERALL LENGTH INCH(mm)	AIR INLET INCH	AIR HOSE I.D.	AVG. AIR CONSUMPTION cfm(L/min)	NET WEIGHT lb(kg)
KI-3276	P16	5~75 (0.6~8.5)	3,000	8.1 (206)	1/4	3/8	3.9 (111)	2.60 (1.18)
KI-3280	P16	5~140 (0.6~15.8)	1,200	9.4 (238)	1/4	3/8	3.9 (110)	3.29 (1.49)
KI-3272	P16	17~100 (1.9~11.3)	2,200	8.1 (206)	1/4	3/8	3.9 (111)	2.60 (1.18)
KI-3275	P18	20~75 (2.3~8.5)	3,000	8.3 (210)	1/4	3/8	3.9 (111)	2.76 (1.25)
KI-3220	P32	20~115 (2.3~13.0)	1,800	7.5 (190)	1/4	3/8	4.0 (113)	2.49 (1.13)
KI-3215	P31	20~115 (2.3~13.0)	1,800	8.5 (215)	1/4	3/8	3.0 (85)	2.65 (1.20)
KI-3217	P31	20~115 (2.3~13.0)	1,800	8.5 (215)	1/4	3/8	3.0 (85)	2.71 (1.23)
KI-3279	P18	20~140 (2.3~15.8)	1,200	9.3 (237)	1/4	3/8	3.9 (111)	3.35 (1.52)
KI-3271	P18	37~100 (4.2~11.3)	2,200	8.3 (210)	1/4	3/8	3.6 (102)	2.76 (1.25)
KI-3277	P12	65 (7.3)	3,000	5.9 (151)	1/4	3/8	3.9 (111)	2.16 (0.98)
KI-3251	P32	70 (7.90)	1,800	6.7 (170)	1/4	3/8	4.0 (113)	2.43 (1.10)
KI-3273	P12	75 (8.5)	2,200	5.9 (151)	1/4	3/8	3.9 (111)	2.16 (0.98)
KI-3274	P14	75 (8.5)	3,000	7.1 (180)	1/4	3/8	3.9 (111)	2.47 (1.12)
KI-3270	P14	100 (11.3)	2,200	7.1 (180)	1/4	3/8	3.9 (111)	2.47 (1.12)
KI-3281	P12	120 (13.6)	1,200	7.3 (185)	1/4	3/8	3.9 (111)	2.80 (1.27)
KI-3278	P14	140 (15.8)	1,200	8.4 (213)	1/4	3/8	3.9 (111)	2.47 (1.12)
KI-3201-QL	P23	600 (68)	11,000	7.5 (190)	1/4	3/8	2.5 (71)	1.61 (0.73)
KI-3221-QC	P29	960 (108)	12,000	5.7 (146)	1/4	3/8	2.1 (59)	1.21 (0.55)
KI-3266-P-QL	P21	1,800 (203)	8,500	6.9 (175)	1/4	3/8	2.5 (71)	2.76 (1.25)
KI-3202-P-QL	P22	1,800 (203)	8,500	7.6 (192)	1/4	3/8	2.5 (71)	2.87 (1.30)
KI-3202-QL	P22	1,800 (203)	8,500	8.0 (202)	1/4	3/8	2.5 (71)	1.98 (0.90)
KI-411-JHS	P28	1,800 (271)	10,000	5.5 (139)	1/4	3/8	2.5 (71)	2.98 (1.35)
KI-311-JS	P28	1,800 (271)	10,000	5.5 (140)	1/4	3/8	2.5 (71)	2.98 (1.35)
KI-3290-P-QL	P21	3,000 (339)	8,500	7.0 (177)	1/4	3/8	4.5 (127)	1.76 (0.80)
KI-3291-P-QL	P21	4,200 (475)	7,300	6.9 (176)	1/4	3/8	2.3 (65)	2.49 (1.13)
KI-3269-P-QL	P27	4,200 (475)	10,000	6.1 (155)	1/4	3/8	4.2 (119)	2.87 (1.30)
KI-3238A	P24		11,000	7.2 (183)	1/4	3/8	2.8 (79)	1.81 (0.82)

SCREWDRIVER

To improve this tool, minor adjustments might have been applied in each batch. Please check the latest figures to confirm your preferences.

Index Sequenced by Capacity > Torque Range > Free Speed

MODEL	PAGE	CAPACITY INCH(mm)	TORQUE RANGE in-lb(Nm)	FREE SPEED R. P. M.	DIAMETER INCH(mm)	OVERALL LENGTH INCH(mm)	AIR INLET INCH	AIR HOSE I.D	AVG. AIR CONSUMPTION cfm(L/min)	NET WEIGHT lb(kg)
KI-33117-PLUA	P54	3/32(2.2)	6.2~13.2 (0.7~1.5)	1,700	0.6 (16.0)	6.7 (170)	1/4	1/4	7.0 (198)	1.57 (0.71)
KI-33123-PLUA	P54	7/64(2.6)	3.5~8.8 (0.4~1)	2,300	0.6 (16.0)	6.7 (170)	1/4	1/4	7.0 (198)	1.57 (0.71)
KI-33111-PLUA	P54	7/64(2.6)	9.7~18.5 (1.1~2.1)	1,100	0.6 (16.0)	6.7 (170)	1/4	1/4	7.0 (198)	1.57 (0.71)
KI-33023-SLUA	P52	1/8(3)	3.5~8.8 (0.4~1)	2,300	0.6 (15.0)	9.0 (229)	1/4	1/4	7.0 (198)	1.17 (0.53)
KI-34121-PLUA	P55	1/8(3)	8.8~13.2 (1~1.7)	2,100	0.7 (17.0)	6.9 (175)	1/4	1/4	10.5 (297)	1.92 (0.87)
KI-33017-SLUA	P52	9/64(3.5)	6.2~13.2 (0.7~1.5)	1,700	0.6 (15.0)	9.0 (229)	1/4	1/4	7.0 (198)	1.57 (0.71)
KI-33017-STUA	P49	9/64(3.5)	6.2~13.2 (0.7~1.5)	1,700	0.6 (15.5)	7.4 (187)	1/4	1/4	7.0 (198)	0.95 (0.53)
KI-33023-SLWA	P41	9/64(3.5)	8.8~13.2 (1~1.5)	2,300	0.6 (15.0)	10.3 (261)	1/4	1/4	7.1 (200)	1.41 (0.64)
KI-33023-STWA	P38	9/64(3.5)	8.8~13.2 (1~1.5)	2,300	0.6 (15.5)	8.4 (214)	1/4	1/4	7.1 (200)	1.21 (0.55)
KI-33123-PLWA	P43	9/64(3.5)	8.8~13.2 (1~1.5)	2,300	0.6 (16.0)	7.2 (183)	1/4	1/4	7.1 (200)	1.63 (0.74)
KI-34115-PLUA	P55	9/64(3.5)	8.8~19.4 (1~2.2)	1,500	0.7 (17.0)	6.9 (175)	1/4	1/4	10.5 (297)	1.92 (0.87)
KI-33018-STWA	P37	9/64(3.5)	8.9~26.6 (1~3)	1,800	0.6 (15.5)	9.7 (247)	1/4	1/4	2.1 (59)	1.63 (0.74)
KI-33011-SLUA	P52	9/64(3.5)	9.7~18.5 (1.1~2.1)	1,100	0.6 (15.0)	9.0 (229)	1/4	1/4	7.0 (198)	1.17 (0.53)
KI-33009-STWA	P37	5/32(4)	4.4~31 (0.5~3.5)	900	0.6 (15.5)	9.7 (247)	1/4	1/4	2.1 (59)	1.68 (0.76)
KI-34021-SLUA	P53	5/32(4)	8.8~13.2 (1~1.7)	2,100	0.7 (17.0)	9.8 (249)	1/4	1/4	10.5 (297)	1.54 (0.70)
KI-33017-SLWA	P41	5/32(4)	8.8~17.6 (1~2)	1,700	0.6 (15.0)	10.3 (261)	1/4	1/4	7.1 (200)	1.41 (0.64)
KI-33017-STWA	P38	5/32(4)	8.8~17.6 (1~2)	1,700	0.6 (15.5)	8.4 (214)	1/4	1/4	7.1 (200)	1.21 (0.55)
KI-34015-STUA	P50	5/32(4)	8.8~19.4 (1~2.2)	1,500	0.6 (16.5)	8.2 (209)	1/4	1/4	10.5 (297)	1.43 (0.65)
KI-34015-SLUA	P53	5/32(4)	8.8~19.4 (1~2.2)	1,500	0.7 (17.0)	9.8 (249)	1/4	1/4	10.5 (297)	1.54 (0.70)
KI-33011-SLWA	P41	5/32(4)	8.8~22 (1~2.5)	1,100	0.6 (15.0)	10.3 (261)	1/4	1/4	7.1 (200)	1.41 (0.64)
KI-33011-STWA	P38	5/32(4)	8.8~22 (1~2.5)	1,100	0.6 (15.5)	8.4 (214)	1/4	1/4	7.1 (200)	1.21 (0.55)
KI-34021-STWA	P39	5/32(4)	8.8~22 (1~2.5)	2,100	0.6 (16.5)	9.2 (233)	1/4	1/4	10.6 (300)	1.48 (0.67)
KI-34121-PLWA	P44	5/32(4)	8.8~22 (1~2.5)	2,100	0.7 (17.0)	7.6 (194)	1/4	1/4	10.6 (300)	1.92 (0.87)
KI-33011-STUA	P49	5/32(4)	9.7~18.5 (1.1~2.1)	1,100	0.6 (15.5)	7.4 (187)	1/4	1/4	7.0 (198)	0.95 (0.43)
KI-35117-PLUA	P56	5/32(4)	13.2~23 (1.5~2.6)	1,700	0.8 (20.0)	7.8 (198)	1/4	3/8	17.5 (496)	2.65 (1.20)
KI-34108-PLUA	P55	5/32(4)	14.1~35.2 (1.6~4)	800	0.7 (17.0)	6.9 (175)	1/4	1/4	10.5 (297)	1.92 (0.87)
KI-35108-PLUA	P56	5/32(4)	26.4~48.4 (3~5.5)	800	0.8 (20.0)	7.8 (198)	1/4	3/8	17.5 (496)	2.65 (1.20)
KI-35017-STUA	P51	5/32~13/64 (4~5)	13.2~23 (1.5~2.6)	1,700	0.8 (19.5)	9.4 (240)	1/4	3/8	17.5 (496)	2.21 (1.00)
KI-35017-STWA	P40	5/32~13/64 (4~5)	13.2~30.8 (1.5~3.5)	1,700	0.8 (19.5)	10.1 (257)	1/4	3/8	17.7 (500)	2.21 (1.00)
KI-35117-PLWA	P45	5/32~13/64 (4~5)	13.2~30.8 (1.5~3.5)	1,700	0.8 (20.0)	8.4 (213)	1/4	3/8	17.7 (500)	2.65 (1.20)
KI-35008-STWA	P40	5/32~15/64 (4~6)	13.2~52.8 (1.5~6)	800	0.8 (19.5)	10.1 (257)	1/4	3/8	17.7 (500)	2.21 (1.00)
KI-35108-PLWA	P45	5/32~15/64 (4~6)	13.2~52.8 (1.5~6)	800	0.8 (20.0)	8.4 (213)	1/4	3/8	17.7 (500)	2.65 (1.20)
KI-35005-STWA	P40	5/32~15/64 (4~6)	17.6~88 (2~10)	480	0.8 (19.5)	10.1 (257)	1/4	3/8	17.7 (500)	2.21 (1.00)
KI-35105-PLWA	P45	5/32~15/64 (4~6)	17.6~88 (2~10)	480	0.8 (20)	8.4 (213)	1/4	3/8	17.7 (500)	2.65 (1.20)

To improve this tool, minor adjustments might have been applied in each batch.
Please check the latest figures to confirm your preferences.

SOUND & VIBRATION

Index sequenced by Model

MODEL	PAGE	Sound				Vib.		Report No.
		Pressure	Power	Pressure	K	M/S ²	K	
		db(A)	db(A)	db(C)	(DB)			
KI-311-JS	P28	89.6	100.6	114	3	5.68	1.10	1508005
KI-3201-QL	P23	86	97	101	3	3.56	0.80	1508008
KI-3202-P-QL	P22	93.4	104.4	119	3	4.34	0.90	1508009
KI-3202-QL	P22	93	104	116	3	7.77	1.30	1508010
KI-3211	P30	91.4	102.4	106	3	1.01	0.59	1502001
KI-3213	P30	90.1	101.1	105	3	1.11	0.61	1502003
KI-3215	P31	95.4	106.4	109	3	0.97	0.59	1501003
KI-3217	P31	96.4	107.4	110	3	0.69	0.56	1501004
KI-3220	P32	92.1	103.1	105	3	1.23	0.61	1501006
KI-3221-QC	P29	97.9	108.9	111	3	6.44	1.14	1508025
KI-3238A	P23	92.8	103.8	114	3	3.83	0.90	1509018
KI-3251	P32	87.2	98.2	98.1	3	0.43	0.54	1502005
KI-3266-P-QL	P21	94.5	105.5	118	3	5.02	1.00	1508022
KI-3269-P-QL	P27	91.3	102.3	117	3	7.84	1.30	1506014
KI-3270	P14	88.9	99.9	103	3	1.58	0.60	1508020
KI-3271	P18	88.1	99.1	102	3	2.45	0.70	1508019
KI-3272	P16	88.3	99.3	102	3	1.41	0.60	1508018
KI-3273	P12	87.9	98.9	102	3	2.07	0.70	1508017
KI-3274	P14	88.6	99.6	102	3	1.48	0.60	1508016
KI-3275	P18	87.1	98.1	99.9	3	3.95	0.90	1508015
KI-3276	P16	88.4	99.4	103	3	3.64	0.90	1507001
KI-3277	P12	88.3	99.3	102	3	3.48	0.80	1508014
KI-3278	P14	89	100	103	3	0.77	0.60	1508013
KI-3279	P18	88.6	99.6	102	3	1.24	0.60	1508027
KI-3280	P16	87.5	98.5	102	3	0.67	0.60	1508026
KI-3281	P12	86.2	97.2	100	3	0.98	0.60	1508024
KI-3290-P-QL	P21	95.3	106.3	121	3	3.98	0.90	1508012
KI-3291-P-QL	P21	91	102	117	3	3.72	0.90	1508004
KI-33006-STWA	P37	80	91	92.7	3	0.61	0.60	1510009
KI-33009-STWA	P37	83	94	100	3	0.80	0.60	1510007
KI-33011-SLUA	P52	77.3	88.3	94.3	3	1.75	0.70	1510030
KI-33011-SLWA	P41	78.8	89.8	95.2	3	1.04	0.60	1510026
KI-33011-STUA	P49	74.5	85.5	90.7	3	1.35	0.63	1511009
KI-33011-STWA	P38	73.7	84.7	89.7	3	1.22	0.60	1510027

To improve this tool, minor adjustments might have been applied in each batch. Please check the latest figures to confirm your preferences.

Index sequenced by Model

MODEL	PAGE	Sound				Vib.		Report No.
		Pressure	Power	Pressure	K	M/S ²	K	
		db(A)	db(A)	db(C)	(DB)			
KI-33017-SLUA	P52	76.8	87.8	94.1	3	1.41	0.60	1510029
KI-33017-SLWA	P41	72.4	83.4	86.7	3	1.34	0.60	1510032
KI-33017-STUA	P51	76.8	87.8	92.6	3	0.72	0.60	1510012
KI-33017-STWA	P40	74.6	85.6	87.9	3	0.85	0.60	1510024
KI-33018-STWA	P37	80.8	91.8	94.8	3	0.94	0.60	1510006
KI-33023-SLUA	P52	71.5	82.5	87.2	3	1.77	0.70	1510031
KI-33023-SLWA	P41	70.4	81.4	84.5	3	2.45	0.70	1511004
KI-33023-STUA	P49	71.9	82.9	89.1	3	1.74	0.70	1510010
KI-33023-STWA	P38	72.2	83.2	87.9	3	1.77	0.70	1511007
KI-33111-PLUA	P54	68.7	79.7	82.7	3	0.73	0.60	1509005
KI-33111-PLWA	P43	72.6	83.6	88	3	1.90	0.70	1509002
KI-33117-PLUA	P54	69.6	80.6	84.2	3	1.51	0.64	1509004
KI-33117-PLWA	P43	69.7	80.7	84.1	3	2.67	0.80	1509007
KI-33123-PLUA	P54	68.1	79.1	84	3	1.34	0.63	1511010
KI-33123-PLWA	P43	68.2	79.2	82.4	3	0.91	0.60	1511008
KI-34003-CGWC	P59	88.9	99.9	104	3	0.28	0.50	1511002
KI-34003-CGWD	P59	86.2	97.2	102	3	0.28	0.50	1510004
KI-34003-CLWC	P60	84.4	95.4	100	3	0.14	0.51	1511003
KI-34003-CLWD	P60	83.7	94.7	99.9	3	0.28	0.50	1510003
KI-34008-SLUA	P53	77.1	88.1	89.3	3	1.38	0.60	1510018
KI-34008-SLWA	P42	76.3	87.3	91.5	3	0.58	0.50	1510023
KI-34008-STUA	P50	77	88	89.5	3	1.22	0.60	1510013
KI-34008-STWA	P39	78.6	89.6	95.1	3	0.51	0.50	1510008
KI-34015-SLUA	P53	74.4	85.4	87.1	3	1.20	0.60	1510014
KI-34015-SLWA	P42	75.6	86.6	89.8	3	1.63	0.70	1510022
KI-34015-STUA	P50	76.5	87.5	89.7	3	0.92	0.60	1510017
KI-34015-STWA	P39	79.1	90.1	94.7	3	0.86	0.60	1510005
KI-34021-SLUA	P53	73.6	84.6	86.5	3	4.41	0.90	1510016
KI-34021-SLWA	P42	74.6	85.6	88.1	3	1.51	0.60	1510025
KI-34021-STUA	P50	76.9	87.9	92.7	3	1.49	0.60	1510011
KI-34021-STWA	P39	76.9	87.9	91.8	3	0.97	0.60	1510021
KI-34108-PLUA	P55	72.4	83.4	87.5	3	1.18	0.61	1509010
KI-34108-PLWA	P44	72.7	83.7	90	3	0.86	0.60	1509003
KI-34115-PLUA	P55	71	82	85.5	3	1.59	0.70	1509008

To improve this tool, minor adjustments might have been applied in each batch. Please check the latest figures to confirm your preferences.



Kuani Gear Co Ltd

Head Office
Room 6, Floor 11, No.891-43
Zhongzheng Rd.,
Xinzhuang Dist.,
New Taipei City,
Post Code 24257
Taiwan
Tel: +886-(0)2-2903-3740
Fax: +886-(0)2-2902-8865



201707-002